

# TIRE & WHEEL SOLUTIONS CATALOG



## The Tire & Wheel Authority Technicians Trust



## TECH... Providing World Class Products and World Class Customer Service!



TECH's Customer Service Team is dedicated to providing great personal service. Whether it is product information, order entry assistance or shipping information, they are available to assist all TECH customers.



**By Phone:**  
800-705-2206  
740-967-9015



**Online:**  
techorders@techtirerepairs.com



**World Class customer Service ...  
Yet another reason TECH is the  
Global Tire & Wheel Authority!**

## TECH Catalog Table of Contents



### Tire Repair Materials

• Uni-Seal Repairs	8-10
• Centech Repairs	11-13
• Bias Ply Repairs	14-15
• Centech OTR Repairs	16-19
• 2-Way Repairs	20
• All Purpose Repairs	21
• Rope Rubber, Vulgum, AB, Tire Sealants	22-23
• Permacure & Repair Kits	24-27

### Chemicals

• Mounting & Demounting Chemicals	30
• Rubber Cleaner	31
• Other Chemicals	31
• Tire & Wheel Service Lubricants	31
• Vulcanizing Fluid	32

### Service Tools & Equipment

• Tire Repair Hand Tools	36-38
• Cutters, Burrs & Rasps	39
• Tire Repair Tools	40-45
• Air Tools & Accessories	46-48
• Sockets	49-57
• Torque Wrenches & Extension	58-59
• Air Gauges, Chucks & Couplers	60-63
• Vulcanizing Equipment	64-66
• Extruder Guns	67-68
• Wheel Service Tools	69-70
• Mount/Demount	71-78
• Lifting	79
• Shop Equipment & Tools	80-99
• Tire Spreaders	100
• Workers Safety & Protection Items	101

### Wheel & Tire Supplies

• TPMS	104-107
• Valves	108-121
• Wheel Weights	122-124
• Lead Free Balancing Pads	125
• Balance Compound	125

### Repair Charts

126-134

### Product Index

135

## TECH Tire Repair System



TECH has over 80 years of experience, expertise and innovation in developing proper and permanent tire repair products.

TECH tire repairs and chemicals are engineered and manufactured to work with each other. Supplementing another product other than TECH product will result in a compromised and potentially unsafe repair.

Look for this  TECH Tire Repair System icon throughout our catalog that identifies the repairs and chemicals which are components of TECH's proprietary repair system.



TECH  
200 East Coshocton Street  
P.O. Box 486  
Johnstown, Ohio  
43031-0486, U.S.A.

To our worldwide customers,

We are in a time of significant change. Electric vehicles, self-driving vehicle technologies and ride-sharing are just a few ways our customers are evolving. However, one thing has been constant throughout the years: billions of pneumatic tires roll down roads and highways every day around the world.

At Tech, we are proud to serve the hard-working men and women who keep the world rolling. We are pleased to combine a complete range of wheel-service products and world-class training to be certain that every repair is properly installed to last the life of the tire. From small passenger tires to large earthmover tires, Tech has all the repairs, chemicals, and tools you need.

Thank you for your business. We are pleased to celebrate our 80th anniversary in 2019, which would not be possible without so many long-term relationships. And we look forward to another 80+ years of serving our customers.

Sincerely,

Dan Layne  
Chairman & CEO

## 4r Future Vision

# Repair, Reuse, Recycle & Repurpose

## Annual global savings of Tech Tire Repairs versus manufacturing replacement tires:

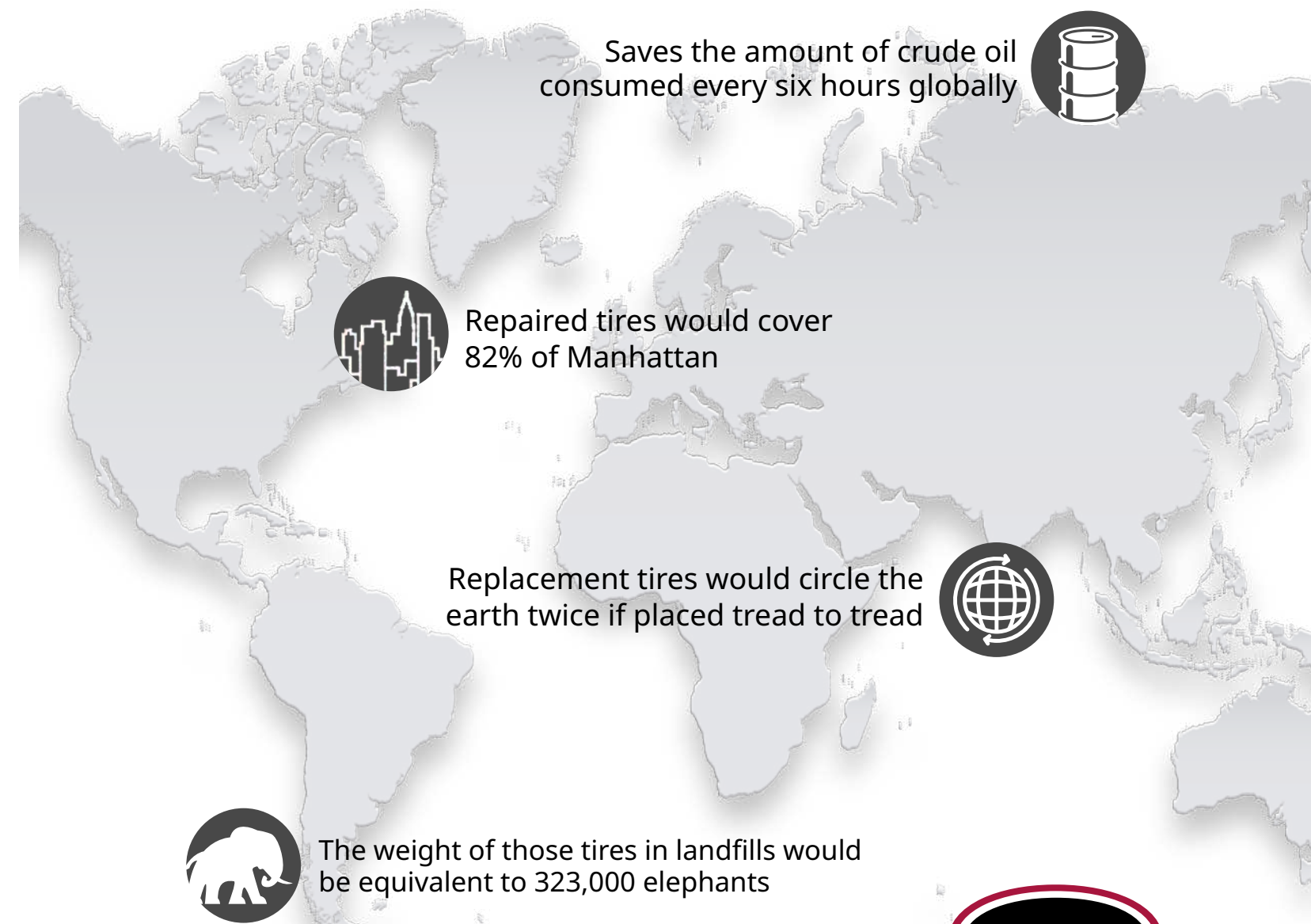

A TRC Company



# OUR EXPERTISE

Because our customers deliver the best in their industries, they expect the best from us. With products for heavy truck, off-the-road, agriculture, passenger and light truck, we have the high-quality tire and wheel repair products the experts trust.



## OUR HISTORY

For eight decades, we've manufactured rubber and industrial material solutions, solidified under our family-owned values. Our founder, Charles Cornell, with the invention of the cold vulcanization process, revolutionized the tire repair industry and built the foundation to grow a global organization through four generations of family ownership and leadership.

## OUR VISION

Supporting the entire lifecycle of rubber, our vision is to create and extract value from materials that were formerly considered to be at the end of their useful life.

- **Repair**
- **Reuse**
- **Recycle**
- **Repurpose**

## OUR PROMISE

By empowering our customer partnerships with a complete range of proven tire and wheel service solutions, we have become the tire and wheel authority that's trusted by top technicians across the globe. Tech products have repaired billions of tires, with every repair guaranteed for the life of the tire.

## THE WORK WE DO

We are one of two U.S. companies that has been awarded the United States Presidential E-Star Award twice. We have also been recognized for the EY Entrepreneur of the Year Award; we won this award in 1993 and were a finalist in 2017.



## OUR REACH

### Global Manufacturing, Testing and Distribution

In addition to being ISO certified, our product testing exceeds U.S. DOT Standards. With global manufacturing and distribution in 96 countries, Tech is the worldwide pioneer in tire and wheel service solutions.

USA Brazil Belgium Italy Thailand China Japan

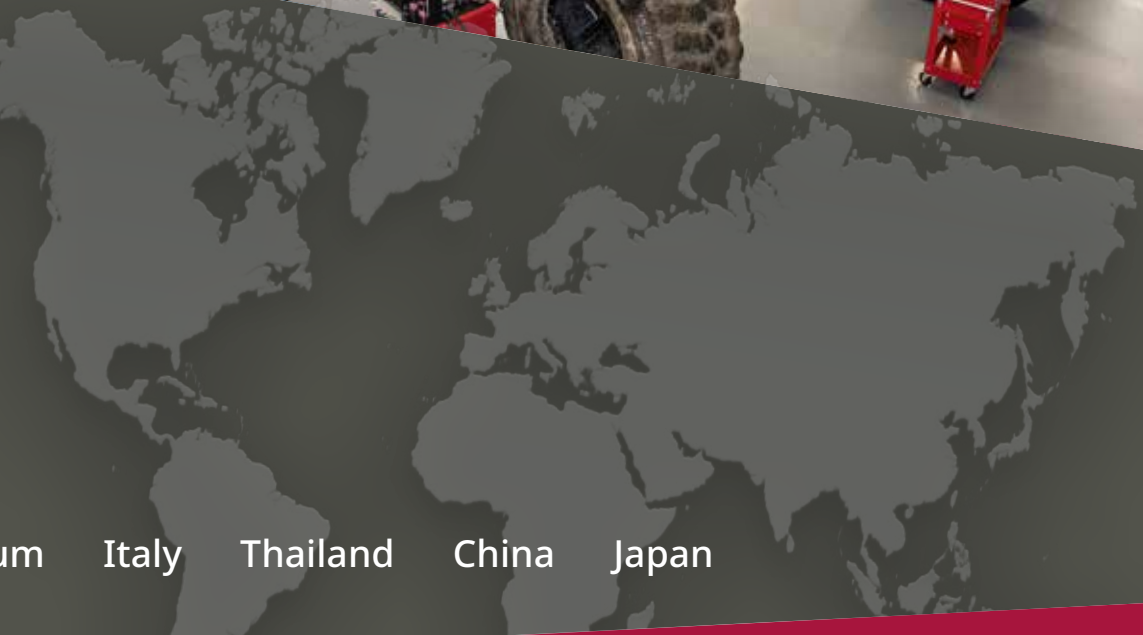



# Tire Repair Materials

TECH tire repairs embody over 80 years of innovation, refinement, enhanced tire longevity, customer confidence and safety. With billions of tire repairs installed globally, TECH tire repairs last the life of the tire as well as meet all global published government and industry standards for proper tire repair. TECH produced tire repairs are endorsed and are used by the world's largest tire manufacturers/retreaders and their subsidiaries. TECH offers a complete range of tire and tube repairs for every repair process from bicycle to Off-the-Road.

## TECH Uni-Seal Ultra Repairs

- Gray cushion gum on the cap permanently bonds the repair to the tire.
- Gray cushion gum on the rubber stem to permanently seal out moisture and contaminants. Lead wire for easy installation.
- Can be used in radial and bias tires.



Item No.	Description	Prepared Injury Size mm / in.	Box Qty.				
249UL	UL3 UNI-SEAL ULTRA	3mm / 1/8"	24	•	•		
250UL	UL6 UNI-SEAL ULTRA	6mm / 1/4"	14	•	•	•	
250UL/24*	UL6 UNI-SEAL ULTRA	6mm / 1/4"	24	•	•	•	
251UL	UL8 UNI-SEAL ULTRA	8mm / 5/16"	14	•	•	•	
251UL/24*	UL8 UNI-SEAL ULTRA	8mm / 5/16"	24	•	•	•	
290UL	UL10N NON-FABRIC-REINFORCED UNI-SEAL ULTRA	10mm / 3/8"	10		•	•	•

\*Item not shown

## TECH Uni-Seal Ultra Max Repairs

- Cross-weave fabric offers reinforcement for both radial and bias tires.
- Gray cushion gum on the cap and stem permanently bonds the repair to the tire and seals out moisture and contaminants.
- Lead wire for easy installation.



Item No.	Description	Prepared Injury Size mm / in.	Box Qty.				
291UL	UL10 UNI-SEAL ULTRA MAX	10mm / 3/8"	10	•	•	•	•
292UL	UL13 UNI-SEAL ULTRA MAX	13mm / 1/2"	10		•	•	•

## TECH Bias Uni-Seal Repairs

- Gray cushion gum on the cap and stem permanently bonds the repair to the tire and seals out moisture and contaminants.
- Fabric reinforced for use in bias tires only.

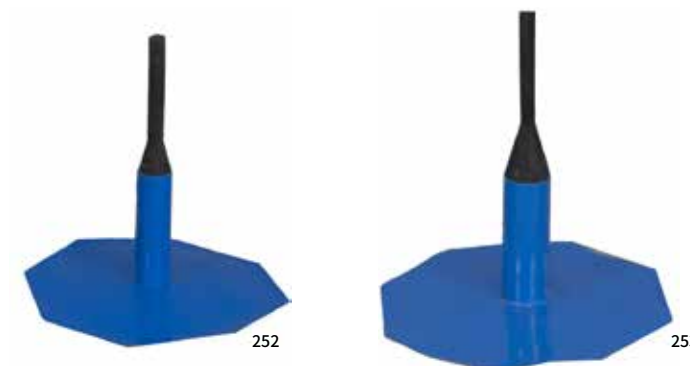

Item No.	Description	Prepared Injury Size mm / in.	Box Qty.			
252	BIAS UNI-SEAL	13mm / 1/2"	6	•	•	•
253	BIAS UNI-SEAL, 14 ply rated	20mm / 3/4"	6		•	•

## TECH 2-Piece Uni-Seal Ultra Stems

- Gray cushion gum on the stem permanently bonds the repair to the tire and seals out moisture and contaminants.
- Lead wire for easy installation.
- Must be used in conjunction with the appropriate repair unit on the inside of the tire.



Item No.	Description	Prepared Injury Size mm / in.	Box Qty.				
250-1UL	ULS6 UNI-SEAL ULTRA STEM	6mm / 1/4"	20	•	•	•	
251-1UL	ULS8 UNI-SEAL ULTRA STEM	8mm / 5/16"	20	•	•	•	
291-1UL	ULS10 UNI-SEAL ULTRA STEM	10mm / 3/8"	20		•	•	•



## TECH 2-Piece Large Uni-Seal Stems

- Gray cushion gum on the rubber stem to permanently seal out moisture and contaminants.
- Must be used in conjunction with the appropriate repair unit on the inside of the tire.



Item No.	Description	Prepared Injury Size mm / in.	Box Qty.			
252-1	UNI-SEAL STEM with Chemical Gum	13mm / 1/2"	10	•	•	•
253-1	UNI-SEAL STEM with Chemical Gum	20mm / 3/4"	10		•	•
254-1	UNI-SEAL STEM with Chemical Gum	25mm / 1"	10		•	•

## TECH MP (Multi-Purpose) Repair Units

- TECH Multi-Purpose (MP) repairs are produced with a unique cross-weave reinforcement and thick chemical cushion gum.
- Provides excellent performance in both radial and bias tires.



Item No.	Description	Dim. (mm)	Dim. (inches)	Box Qty.			
600	MP-0 MULTI-PURPOSE REPAIR	60	2 1/4	25	•	•	•
600T	MP-0 MULTI-PURPOSE REPAIR	60	2 1/4	80	•	•	•
601	MP-1 MULTI-PURPOSE REPAIR	75	3	20	•	•	•
602	MP-2 MULTI-PURPOSE REPAIR	90	3 1/2	10		•	•

\*For injury size please refer to the appropriate repair chart located on page 128.

## TECH Radial Center-Over-Injury Centech Repair Units

- TECH Centech repairs are fabric reinforced for use in radial tires.
- Thick chemical cushion gum permanently vulcanizes to the tire.
- Must be used in conjunction with the appropriate repair stem.



Item No.	Description	Dim. (mm)	Dim. (inches)	Box Qty.				
165	CT-10	45 x 75	1 3/4 x 3	20	•	•		
165T*	CT-10 in plastic tub	45 x 75	1 3/4 x 3	80	•	•		
164	CT-10HD	65 x 80	2 1/2 x 3 1/4	10	•	•	•	
166*	CT-12HD	70 x 115	2 3/4 x 4 5/8	10	•	•	•	
167*	CT-12	60 x 110	2 3/8 x 4 3/8	10	•	•	•	
167T*	CT-12 in plastic tub	60 x 110	2 3/8 x 4 3/8	40	•	•	•	
169*	CT-14	75 x 145	3 x 5 3/4	10	•	•		
170*	CT-20	75 x 125	3 x 5	10		•	•	•

\*Item not shown

## TECH Radial Centech Shoulder Repair Units



Item No.	Description	Dim. (mm)	Dim. (inches)	Box Qty.			
172	CT-22	75 x 165	3 x 6 1/2	10	•	•	•
174	CT-24	75 x 215	3 x 8 1/2	10	•	•	•
RSR-26*	CT-26-RSR	75 x 250	3 x 10	10	•	•	•

\*Item not shown



## TECH Centech Radial Repair Units

- TECH Centech repairs are fabric reinforced for use in radial tires.
- Thick chemical cushion gum permanently vulcanizes to the tire.

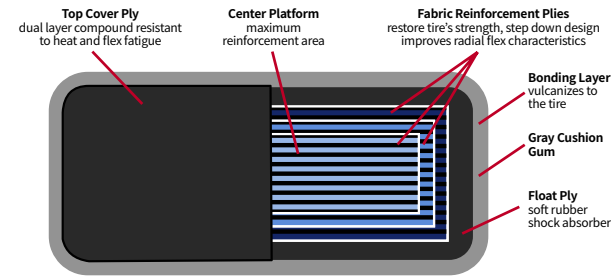

Item No.	Description	Dim. (mm)	Dim. (inches)	Box Qty.		
177	CT-33 Centech Repair Units	100 x 125	4 x 5	10	•	•
178	CT-35 Centech Repair Units	125 x 150	5 x 6	10	•	•
179	CT-37 Centech Repair Units	125 x 170	5 x 6 <sup>3</sup> / <sub>4</sub>	5	•	•

Refer to Repair Applications Chart on page 129.

## Centech Center-Over-Injury Repair Units



Item No.	Description	Dim. (mm)	Dim. (inches)	Box Qty.			
176	CT-26 Centech Repair Units	75 x 250	3 x 10	10	•	•	•
180	CT-40 Centech Repair Units	100 x 200	4 x 8	10	•	•	•
182	CT-42 Centech Repair Units	125 x 250	5 x 10	5	•	•	•
184	CT-44 Centech Repair Units	125 x 330	5 x 13	5	•	•	•

## Centech Radial AG Repairs



Item No.	Description	Dim. (mm)	Dim. (inches)	Box Qty.		
196	CT-80 Centech Repair Units	150 x 95	4 x 7 <sup>3</sup> / <sub>4</sub>	5	•	•
197	CT-82 Centech Repair Units	190 x 250	7 <sup>1</sup> / <sub>2</sub> x 10	5	•	•
198	CT-84 Centech Repair Units	215 x 290	8 <sup>1</sup> / <sub>2</sub> x 6 <sup>3</sup> / <sub>4</sub>	5	•	•
199	CT-86 Centech Repair Units	245 x 340	9 <sup>3</sup> / <sub>4</sub> x 13 <sup>1</sup> / <sub>2</sub>	5	•	•

Add suffix "R" to Cat. No. to order Thermacure Radial Tractor Repairs.

## TECH Thermacure Repair Units

- TECH Centech repairs are fabric reinforced for use in radial tires.
- Thermacure cushion gum permanently vulcanizes to the tire in hot or cold applications.

### Thermacure Nail Hole Repairs



Item No.	Description	Dim. (mm)	Dim. (inches)	Box Qty.			
111R	Round All Purpose Repair Units	65	2 <sup>1</sup> / <sub>2</sub>	50	•	•	•
112R	MP-10R Repair Units	75	3	30	•	•	•
164R*	CT-10HDR Repair Units	65 x 80	2 <sup>1</sup> / <sub>2</sub> x 3 <sup>1</sup> / <sub>4</sub>	10	•	•	•
166R	CT-12HDR Repair Units	70 x 115	2 <sup>3</sup> / <sub>4</sub> x 4 <sup>5</sup> / <sub>8</sub>	10	•	•	•
170R*	CT-20R Repair Units	75 x 125	3 x 5	10	•	•	•

\*Item not shown  
Refer to Repair Applications Chart on page 129.

### Thermacure Crown Radial Repairs



Item No.	Description	Dim. (mm)	Dim. (inches)	Box Qty.			
177R	CT-33R Repair Units	100 x 125	4 x 5	10	•	•	•
178R	CT-35R Repair Units	125 x 150	5 x 6	10	•	•	•
179R	CT-37R Repair Units	125 x 170	5 x 6 <sup>3</sup> / <sub>4</sub>	5	•	•	•

Refer to Repair Applications Chart on page 129.

### Thermacure Center-Over-Injury Radial Repairs



Item No.	Description	Dim. (mm)	Dim. (inches)	Box Qty.				
172R	CT-22R Repair Units	75 x 165	3 x 6 <sup>1</sup> / <sub>2</sub>	10	•	•	•	•
174R*	CT-24R Repair Units	75 x 215	3 x 8 <sup>1</sup> / <sub>2</sub>	10	•	•	•	•
180R	CT-40R Repair Units	100 x 200	4 x 8	10	•	•	•	•
182R*	CT-42R Repair Units	125 x 250	5 x 10	5	•	•	•	•
184R*	CT-44R Repair Units	125 x 330	5 x 13	5	•	•	•	•
CT46AR*	Aramid Reinforced	140 x 405	5 <sup>1</sup> / <sub>2</sub> x 16	5	•	•	•	•

\*Item not shown  
Refer to Repair Applications Chart on page 129.

## TECH BP Bias Ply Tire Repairs

- TECH BP repair units, produced with soft gray cushion gum, provide excellent adhesion when used with TECH 760 Chemical Vulcanizing Fluid or 775 Heavy Duty Blue Cement.
- Designed to restore the strength and flexibility to bias truck, farm tractor, and small OTR tires.

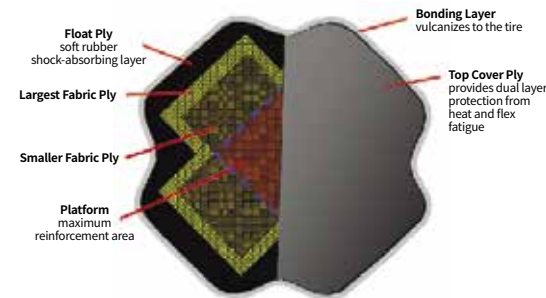

Item No.	Description	Dim. (mm)	Dim. (inches)	Plies	Box Qty.			
603	BP-3 Bias Ply Repair Units	100	4	2	10	•	•	•
604	BP-4 Bias Ply Repair Units	130	5 <sup>5</sup> / <sub>16</sub>	4	10	•	•	•
605	BP-5 Bias Ply Repair Units	165	6 <sup>1</sup> / <sub>2</sub>	4	10	•	•	•

Refer to Repair Applications Chart on page 130.



Item No.	Description	Dim. (mm)	Dim. (inches)	Plies	Box Qty.			
606	BP-6 Bias Ply Repair Units	240	9 <sup>9</sup> / <sub>16</sub>	6	5	•	•	•
607	BP-7 Bias Ply Repair Units	290	11 <sup>5</sup> / <sub>8</sub>	6	5	•	•	•
608	BP-8 Bias Ply Repair Units	340	13 <sup>5</sup> / <sub>8</sub>	6	5	•	•	•
609*	BP-9 Bias Ply Repair Units	380	15 <sup>1</sup> / <sub>8</sub>	8	3	•	•	•
610*	BP-10 Bias Ply Repair Units	430	17 <sup>1</sup> / <sub>8</sub>	8	3	•	•	•

\*Item not shown  
Refer to Repair Applications Chart on page 130.

## BPT Bias Ply Tractor Repair Units

- TECH BPT bias ply repairs are designed with a wide ply reinforcement package that provides strength and flexibility over large injuries in bias agricultural and forestry tires.
- For best results, use with TECH 760 Chemical Vulcanizing Fluid or 775 Heavy Duty Blue Cement.



Item No.	Description	Dim. (mm)	Dim. (inches)	Plies	Box Qty.		
620	BPT-0 Bias Ply Repair Units	200	8	4	10	•	•
621	BPT-1 Bias Ply Repair Units	225	9	4	5	•	•
622*	BPT-2 Bias Ply Repair Units	275	11	4	5	•	•
623*	BPT-3 Bias Ply Repair Units	375	15	4	5	•	•
624*	BPT-4 Bias Ply Repair Units	225	9	6	5	•	•
625*	BPT-5 Bias Ply Repair Units	275	11	6	5	•	•
626*	BPT-6 Bias Ply Repair Units	375	15	6	5	•	•
627*	BPT-7 Bias Ply Repair Units	490	19 <sup>1</sup> / <sub>2</sub>	6	3	•	•

\*Item not shown  
Refer to Repair Applications Chart on page 130.

## TECH BP THERMACURE Bias Ply Tire Repairs

- TECH BP repair units, produced with Thermacure cushion gum, provide excellent adhesion when used with TECH 1082 Tem-Vulc Black Cement or 775 Heavy Duty Blue Cement.
- Designed to restore the strength and flexibility to bias passenger, truck, farm tractor, skidder, and small OTR tires.

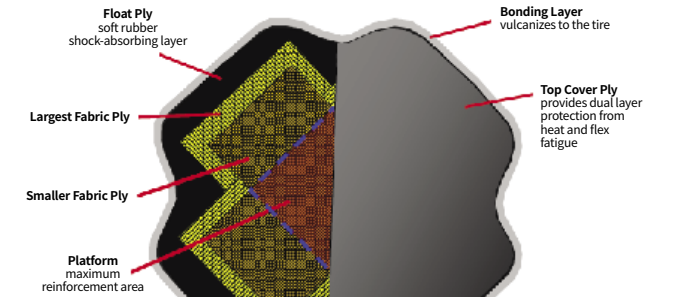

Item No.	Description	Dim. (mm)	Dim. (inches)	Plies	Box Qty.				
603R	BP-3R Thermacure Bias Ply Repairs	100	4	2	10	•	•	•	•
604R	BP-4R Thermacure Bias Ply Repairs	130	5 <sup>5</sup> / <sub>16</sub>	4	10	•	•	•	•
605R	BP-5R Thermacure Bias Ply Repairs	165	6 <sup>1</sup> / <sub>2</sub>	4	10	•	•	•	•
606R*	BP-6R Thermacure Bias Ply Repairs	240	9 <sup>9</sup> / <sub>16</sub>	6	5	•	•	•	•
607R*	BP-7R Thermacure Bias Ply Repairs	290	11 <sup>5</sup> / <sub>8</sub>	6	5	•	•	•	•
608R*	BP-8R Thermacure Bias Ply Repairs	340	13 <sup>5</sup> / <sub>8</sub>	6	5	•	•	•	•
609R*	BP-9R Thermacure Bias Ply Repairs	380	15 <sup>1</sup> / <sub>8</sub>	8	3	•	•	•	•

\*Item not shown  
Refer to Repair Applications Chart on page 130.

## TECH Bias Skidder Repairs

- TECH Bias Skidder repairs are specially designed for forestry application tires. Repairs utilize a wide platform reinforcement package with OTR tire cord for maximum strength.
- Produced with Thermacure soft cushion gum for hot or cold vulcanization.
- For best results use with Heavy Duty Blue Cement for cold repairs or Tem-Vulc Black Cement in heat cure applications.



Item No.	Description	Dim. (mm)	Dim. (inches)	Plies	Box Qty.	
SK12R*	Bias Skidder Repair	300	12	6	5	•
SK16R*	Bias Skidder Repair	400	16	6	3	•
SK20R	Bias Skidder Repair	500	20	6	3	•
SK24R*	Bias Skidder Repair	600	24	8	1	•

\*Item not shown

## CENTECH Aramid Reinforced Radial OTR Repairs

- Centech Radial OTR repairs are reinforced with Aramid cord for maximum strength.
- Advanced rubber compounds provide longer performance life in the most extreme OTR tire service conditions.
- Centech Radial OTR repairs are very flexible, resulting in easy installation, minimizing the chances of trapped air as well as restoring the strength of the tire with little resistance to the tire's flex characteristics.

### Center-Over-Injury Thermacure OTR Repairs with Aramid Reinforcement

Item No.	Description	Dim. (mm)	Dim. (inches)	Box Qty.	
CT46AR*	Thermacure Aramid OTR Repair	156 x 416	6 <sup>1</sup> / <sub>8</sub> x 16 <sup>3</sup> / <sub>8</sub>	5	•
CT50AR*	Thermacure Aramid OTR Repair	200 x 486	8 x 19 <sup>1</sup> / <sub>8</sub>	3	•
CT52AR*	Thermacure Aramid OTR Repair	250 x 570	10 x 22 <sup>1</sup> / <sub>2</sub>	3	•
CT56AR*	Thermacure Aramid OTR Repair	265 x 748	10 <sup>1</sup> / <sub>2</sub> x 29 <sup>1</sup> / <sub>2</sub>	3	•
CT60AR*	Thermacure Aramid OTR Repair	265 x 860	10 <sup>1</sup> / <sub>2</sub> x 34	3	•
CT62AR*	Thermacure Aramid OTR Repair	325 x 1030	12 <sup>1</sup> / <sub>2</sub> x 40 <sup>1</sup> / <sub>2</sub>	1	•
CT72AR*	Thermacure Aramid OTR Repair	345 x 760	13 <sup>3</sup> / <sub>4</sub> x 30	1	•

\*Item not shown

### Center-Over-Injury Cloth Back OTR Repairs with Aramid Reinforcement



Item No.	Description	Dim. (mm)	Dim. (inches)	Box Qty.	
CT46AC*	Cloth Back Aramid OTR Repair	156 x 416	6 <sup>1</sup> / <sub>8</sub> x 16 <sup>3</sup> / <sub>8</sub>	5	•
CT50AC	Cloth Back Aramid OTR Repair	200 x 486	8 x 19 <sup>1</sup> / <sub>8</sub>	3	•
CT52AC*	Cloth Back Aramid OTR Repair	250 x 570	10 x 22 <sup>1</sup> / <sub>2</sub>	3	•
CT55AC	Cloth Back Aramid OTR Repair	330 x 260	13 x 10 <sup>1</sup> / <sub>4</sub>	3	•
CT56AC*	Cloth Back Aramid OTR Repair	265 x 748	10 <sup>1</sup> / <sub>2</sub> x 29 <sup>1</sup> / <sub>2</sub>	3	•
CT60AC*	Cloth Back Aramid OTR Repair	265 x 860	10 <sup>1</sup> / <sub>2</sub> x 34	3	•
CT62AC*	Cloth Back Aramid OTR Repair	325 x 1030	12 <sup>1</sup> / <sub>2</sub> x 40 <sup>1</sup> / <sub>2</sub>	1	•
CT72AC	Cloth Back Aramid OTR Repair	345 x 760	13 <sup>3</sup> / <sub>4</sub> x 30	1	•

\*Item not shown  
Note: For heat cure application only.

## CENTECH Aramid Reinforced Crown Only Radial OTR Repairs

- Centech Crown Only repair units reduce repair costs by up to 40%.
- Can be used on crown area injuries instead of much larger traditional center over injury repairs, resulting in lower material cost and less preparation time.
- Designed to provide a wider range of placement in the crown area of the tire.

### Crown Only Thermacure OTR Repairs with Aramid Reinforcement

Centech Thermacure repairs with Aramid reinforcement are recommended when the tires are cured with spotters, press systems, section molds or Monaflex systems. Thermacure repair units should be installed with Tech Heavy Duty Blue Cement after the filler rubber has been cured. In heat cure applications the repair unit may also be installed using Tech TemVulc Black Cement.

Item No.	Description	Dim. (mm)	Dim. (inches)	Box Qty.	
CT45AR*	Thermacure Aramid OTR Crown Repair	230 x 195	9 <sup>1</sup> / <sub>8</sub> x 7 <sup>3</sup> / <sub>4</sub>	5	•
CT55AR*	Thermacure Aramid OTR Crown Repair	330 x 260	13 x 10 <sup>1</sup> / <sub>4</sub>	3	•
CT65AR*	Thermacure Aramid OTR Crown Repair	420 x 330	16 <sup>1</sup> / <sub>2</sub> x 13	3	•
CT75AR*	Thermacure Aramid OTR Crown Repair	535 x 450	20 <sup>3</sup> / <sub>4</sub> x 17 <sup>3</sup> / <sub>4</sub>	1	•
CT85AR*	Thermacure Aramid OTR Crown Repair	710 x 560	28 x 22	1	•

\*Item not shown

### Crown Only Heat Cure OTR Repairs with Aramid Reinforcement

Heat cure repairs produced with black heat cure cushion gum are recommended for all heat cure vulcanizing systems. The special heat cure gum resists over cure during section repairs requiring extended cure times. For best results use with TECH Tem-Vulc Black Cement.



Item No.	Description	Dim. (mm)	Dim. (inches)	Box Qty.	
CT45AH	Heat Cure Aramid OTR Crown Repair	230 x 195	9 <sup>1</sup> / <sub>8</sub> x 7 <sup>3</sup> / <sub>4</sub>	5	•
CT55AH*	Heat Cure Aramid OTR Crown Repair	330 x 260	13 x 10 <sup>1</sup> / <sub>4</sub>	3	•
CT65AH	Heat Cure Aramid OTR Crown Repair	420 x 330	16 <sup>1</sup> / <sub>2</sub> x 13	3	•
CT75AH	Heat Cure Aramid OTR Crown Repair	535 x 450	20 <sup>3</sup> / <sub>4</sub> x 17 <sup>3</sup> / <sub>4</sub>	1	•
CT85AH*	Heat Cure Aramid OTR Crown Repair	710 x 560	28 x 22	1	•

\*Item not shown

Item No.	Description	Dim. (mm)	Dim. (inches)	Box Qty.	
CT45AC	Cloth Back Aramid OTR Crown Repair	230 x 195	9 <sup>1</sup> / <sub>8</sub> x 7 <sup>3</sup> / <sub>4</sub>	5	•
CT55AC	Cloth Back Aramid OTR Crown Repair	330 x 260	13 x 10 <sup>1</sup> / <sub>4</sub>	3	•
CT65AC	Cloth Back Aramid OTR Crown Repair	420 x 330	16 <sup>1</sup> / <sub>2</sub> x 13	3	•
CT75AC	Cloth Back Aramid OTR Crown Repair	535 x 450	20 <sup>3</sup> / <sub>4</sub> x 17 <sup>3</sup> / <sub>4</sub>	1	•
CT85AC	Cloth Back Aramid OTR Crown Repair	710 x 560	28 x 22	1	•



## TECH AX Severe Service Radial OTR Repairs

- Proven design, enhanced with a large aramid reinforced platform and advanced rubber compounds to perform in the most extreme service conditions.
- The AX non-flex to non-flex design is recommended for shoulder and sidewall injuries in tires used in severe service applications.
- Recommended for all heat cure vulcanizing systems.

### AX Uncured Repairs

Uncured repairs provide excellent adhesion and appearance when vulcanized in autoclaves, section molds, or with a Monaflex system. Uncured repairs are ready to be installed or can be floated in the tire. For best results, use TECH Tem-Vulc Black Cement.



AX60U

Item No.	Description	Dim. (mm)	Dim. (inches)	Box Qty.	
AX50U*	AX Uncured Repair	200 x 486	8 x 19 <sup>1</sup> / <sub>8</sub>	6	•
AX60U	AX Uncured Repair	215 X 610	8 <sup>1</sup> / <sub>2</sub> x 24	6	•
AX80U*	AX Uncured Repair	240 X 710	9 <sup>1</sup> / <sub>2</sub> x 28	3	•
AX100U*	AX Uncured Repair	280 X 790	11 x 31	3	•
AX120U*	AX Uncured Repair	280 X 890	11 x 35	3	•
AX140U	AX Uncured Repair	370 X 1170	14 <sup>1</sup> / <sub>2</sub> x 46	1	•

\*Item not shown

### AX Cloth Back Repairs

Cloth back repair units are produced on a special cloth backing material which provides optimum bonding surface texture. For best results, use with TECH TemVulc Black Cement and Vul-Gum cushion gum.



AX80C

Item No.	Description	Dim. (mm)	Dim. (inches)	Box Qty.	
AX50C*	AX Cloth Back Repair	200 x 486	8 x 19 <sup>1</sup> / <sub>8</sub>	6	•
AX60C*	AX Cloth Back Repair	215 X 610	8 <sup>1</sup> / <sub>2</sub> x 24	6	•
AX80C	AX Cloth Back Repair	240 X 710	9 <sup>1</sup> / <sub>2</sub> x 28	3	•
AX100C*	AX Cloth Back Repair	280 X 790	11 x 31	3	•
AX120C*	AX Cloth Back Repair	280 X 890	11 x 35	3	•
AX140C*	AX Cloth Back Repair	370 X 1170	14 <sup>1</sup> / <sub>2</sub> x 46	1	•
AX155C*	AX Cloth Back Repair	250 X 1400	10 x 55	1	•

\*Item not shown

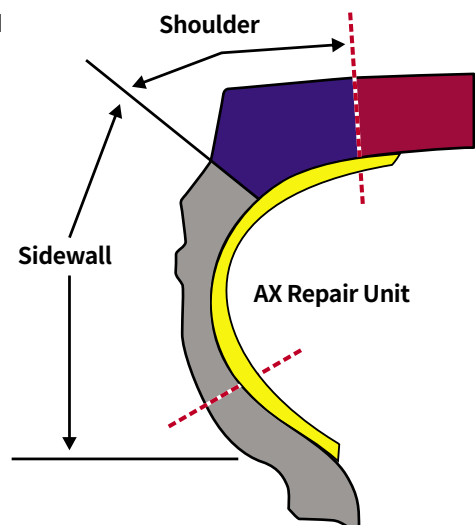

## TECH Off Road (TOR) Bias OTR Repairs

- TECH TOR repairs have specially designed plies that dissipate stress and provide maximum flexibility and strength.
- Advanced rubber compounding throughout the repair construction resists over cure and flex fatigue when the tire is returned to service.

### TOR Thermacure Repairs

Thermacure repairs are recommended for tires cured with spotters, press systems, section molds, or Monaflex systems. Thermacure repair units should be installed with Tech Heavy Duty Blue Cement after the filler rubber has been cured.

Item No.	Description	Diag. Dim. (mm)	Diag. Dim. (inches)	Plies	Box Qty.	
TOR1R	TOR Thermacure Repair	250	9 <sup>3</sup> / <sub>4</sub>	2	10	•
TOR2R*	TOR Thermacure Repair	290	11 <sup>1</sup> / <sub>2</sub>	4	10	•
TOR3R*	TOR Thermacure Repair	310	12 <sup>1</sup> / <sub>4</sub>	4	5	•
TOR4R*	TOR Thermacure Repair	380	15	6	5	•
TOR5R*	TOR Thermacure Repair	475	18 <sup>3</sup> / <sub>4</sub>	6	5	•
TOR6R*	TOR Thermacure Repair	545	21 <sup>3</sup> / <sub>8</sub>	6	3	•
TOR7R*	TOR Thermacure Repair	615	24 <sup>1</sup> / <sub>4</sub>	8	1	•
TOR8R*	TOR Thermacure Repair	690	27 <sup>1</sup> / <sub>4</sub>	8	1	•
TOR9R*	TOR Thermacure Repair	760	30	10	1	•
TOR10R*	TOR Thermacure Repair	830	32 <sup>3</sup> / <sub>4</sub>	10	1	•
TOR11R*	TOR Thermacure Repair	870	34 <sup>1</sup> / <sub>4</sub>	10	1	•

\*Item not shown

### TOR Heat Cure Repairs

Heat Cure cushion gum permanently vulcanizes to the tire in heat cure applications. In heat cure applications the repair unit should be installed using Tech Tem-Vulc Black Cement.

Item No.	Description	Diag. Dim. (mm)	Diag. Dim. (inches)	Plies	Box Qty.	
TOR1H*	TOR Heat Cure Repair	250	9 <sup>3</sup> / <sub>4</sub>	2	10	•
TOR2H*	TOR Heat Cure Repair	290	11 <sup>1</sup> / <sub>2</sub>	4	10	•
TOR3H*	TOR Heat Cure Repair	310	12 <sup>1</sup> / <sub>4</sub>	4	5	•
TOR4H	TOR Heat Cure Repair	380	15	6	5	•
TOR5H*	TOR Heat Cure Repair	475	18 <sup>3</sup> / <sub>4</sub>	6	5	•
TOR6H*	TOR Heat Cure Repair	545	21 <sup>3</sup> / <sub>8</sub>	6	3	•
TOR7H*	TOR Heat Cure Repair	615	24 <sup>1</sup> / <sub>4</sub>	8	1	•
TOR8H*	TOR Heat Cure Repair	690	27 <sup>1</sup> / <sub>4</sub>	8	1	•
TOR9H*	TOR Heat Cure Repair	760	30	10	1	•
TOR10H*	TOR Heat Cure Repair	830	32 <sup>3</sup> / <sub>4</sub>	10	1	•

\*Item not shown

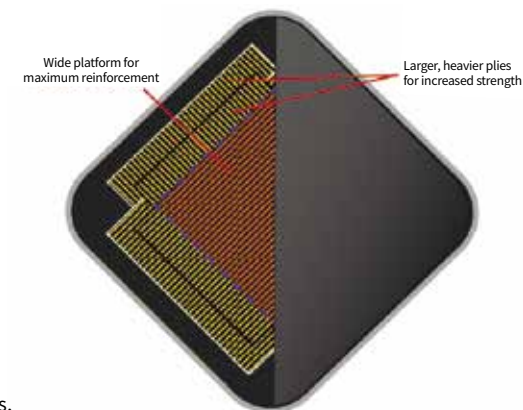

TOR1R



TOR4H

## TECH 2-Way Tube Repairs

- TECH 2-Way repairs are permanent, safe and the repair is twice as strong as the tube itself.
- Made out of a durable, flexible rubber compound capable of repairing injuries on any type of tube.
- TECH's gray cushion gum allows the repairs to be vulcanized hot or cold.

### Round 2-Way Tube Repairs



Item No.	Description	Dim. (mm)	Dim. (inches)	Box Qty.
09*	TINY ROUND	25	1	140
10*	MINI ROUND	35	1 <sup>3</sup> / <sub>8</sub>	50
11	SMALL ROUND	45	1 <sup>3</sup> / <sub>4</sub>	40
12	MEDIUM ROUND	60	2 <sup>1</sup> / <sub>4</sub>	30
13	LARGE ROUND	80	3 <sup>1</sup> / <sub>8</sub>	20
14*	MAXI ROUND	100	4	20
15*	GIANT ROUND	125	5	10
10T*	MINI ROUND TUB	35	1 <sup>3</sup> / <sub>8</sub>	200
11T*	SMALL ROUND TUB	45	1 <sup>3</sup> / <sub>4</sub>	160
12T*	MEDIUM ROUND TUB	60	2 <sup>1</sup> / <sub>4</sub>	100
13T*	LARGE ROUND TUB	80	3 <sup>1</sup> / <sub>8</sub>	75

\*Item not shown

### Oval 2-Way Tube Repairs



Cat. No.	Description	Dim. (mm)	Dim. (inches)	Box Qty.
16*	MINI OVAL	40 x 30	1 <sup>1</sup> / <sub>2</sub> x 1 <sup>1</sup> / <sub>8</sub>	100
17	SMALL OVAL	65 x 40	2 <sup>1</sup> / <sub>2</sub> x 1 <sup>1</sup> / <sub>2</sub>	30
18	MEDIUM OVAL	100 x 50	4 x 2	20
19	LARGE OVAL	150 x 70	6 x 2 <sup>3</sup> / <sub>4</sub>	20
20	GIANT ROUND	160 x 100	6 <sup>1</sup> / <sub>4</sub> x 4	10

\*Item not shown

## TECH All Purpose Repairs



Item No.	Description	Dim. (mm)	Dim. (inches)	Box Qty.
111	AP8 ROUND ALL PURPOSE	65	2 <sup>1</sup> / <sub>2</sub>	50
115	AP4.5 SQUARE ALL PURPOSE	45	1 <sup>3</sup> / <sub>4</sub>	100
116	AP6 SQUARE ALL PURPOSE	55	2 <sup>1</sup> / <sub>4</sub>	80

\*Item not shown

## Tube Replacement Valves



Item No.	TR No.	Description	Box Qty.
6213*	13	PASSENGER VALVE for .453 rim hole, 2 <sup>1</sup> / <sub>2"</sub> , 63mm base diameter	10
6214*	-	RIM HOLE BUSHING for .625 rim hole, protects tube valve	50
6218	218	AIR/LIQUID TRACTOR VALVE, 4 <sup>1</sup> / <sub>4"</sub> , 110mm base diameter	10
6230	-	TRUCK VALVE SPUD, 4 <sup>1</sup> / <sub>4"</sub> , 110mm base diameter	5
VH591	-	PLASTIC RIM NUT for 6218	Ea.
VH592*	-	BRASS RIM NUT for 6218	Ea.

\*Item not shown



## Butyl Retread Envelope Repair System (ERS)

Item No.	Description
672	ERS-45 ENVELOPE REPAIR UNITS, 1 <sup>3</sup> / <sub>4"</sub> , 45mm diameter, 50 ct. tub





## TECH Rope Rubber

- High quality natural rubber compound provides excellent extrusion and workability with maximum adhesion to the tire.
- Outstanding wear and weather resistance.

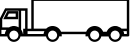

TRRP



Item No.	Description	Diameter (mm/in.)	Package Qty. (lbs/kg)			
LRRP*	ROPE RUBBER for Sidewall Applications	10mm / 3/8"	15 lbs. / 6.8 kg	•	•	•
TRRP	ROPE RUBBER for Tread Applications	10mm / 3/8"	15 lbs. / 6.8 kg	•	•	•

\*Item not shown

## TECH Vul-Gum

- Cushion gum natural rubber compound provides excellent adhesion to prepared rubber surfaces.
- Suitable for floating repair units, filling skives, or spot repairs.

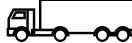

Item No.	Description	Dim. (mm)	Dim. (inches)	Roll Weight (lbs/kg)	Box Qty.			
849BX*	VUL-GUM Cushion Gum	6 x 150	1/4 x 6	10 lbs. / 4.5 kg	1	•	•	•
850BX*	VUL-GUM Cushion Gum	3 x 150	1/8 x 6	10 lbs. / 4.5 kg	1	•	•	•
862BX*	VUL-GUM Cushion Gum	3 x 475	1/8 x 19	10 lbs. / 4.5 kg	1	•	•	•
867BX	VUL-GUM Cushion Gum	1.5 x 475	1/16 x 19	15 lbs. / 6.8 kg	1	•	•	•
868BX*	VUL-GUM Cushion Gum	.8 x 475	1/32 x 19	15 lbs. / 6.8 kg	1	•	•	•
869BX*	VUL-GUM Cushion Gum	3 x 750	1/8 x 30	15 lbs. / 6.8 kg	1	•	•	•
870BX	VUL-GUM Cushion Gum	1.5 x 750	1/16 x 30	15 lbs. / 6.8 kg	1	•	•	•
855BX*	VUL-GUM Stripping Stock	.4 x 25	1/64 x 1	1 lbs. / .5 kg	5	•	•	•
861BX*	VUL-GUM Stripping Stock	3 x 25	1/8 x 1	2 lbs. / .9 kg	9	•	•	•
863BX	VUL-GUM Stripping Stock	1.5 x 25	1/16 x 1	2 lbs. / .9 kg	9	•	•	•
864BX	VUL-GUM Stripping Stock	1.5 x 50	1/16 x 2	4 lbs. / 1.8 kg	4	•	•	•
865BX*	VUL-GUM Stripping Stock	1.5 x 75	1/16 x 3	6 lbs. / 2.7 kg	3	•	•	•
866BX*	VUL-GUM Stripping Stock	1.5 x 100	1/16 x 4	8 lbs. / 3.6 kg	2	•	•	•

\*Item not shown

## TECH Fabric Reinforced Rubber

Item No.	Description	Gauge & Width (mm/inches)	Roll Weight (kg/lbs)	Box Qty.
BT18	Square Woven Polyester	1.5 x 425 / 1/16 x 19	11.5 / 25	1
BN18*	1 Ply Polyester Cord	.8 x 425 / 1/32 x 19	11.5 / 25	1

\*Item not shown



BT18

## TECH Butyl Gum & Chemical Cure Rubber

### Heat Cure Inner Liner Repair Gum

Item No.	Description	Gauge & Width (mm/inches)	Roll Weight (kg/lbs)	Box Qty.
BTLG-125/10#BX*	Butyl Gum	.8 x 425 / 1/32 x 19	4.5 / 10	1
848BX*	Butyl Gum	.8 x 100 / 1/32 x 4	4.5 / 10	1

\*Item not shown

### Chemical Cure Inner Liner Repair Gum

Item No.	Description	Gauge & Width (mm/inches)	Roll Weight (kg/lbs)	Box Qty.
GH100BX*	Chemical Cushion Gum	.8 x 150 / 1/32 x 6	2.72 / 6	1
GH200BX	Chemical Cushion Gum	.8 x 225 / 1/32 x 9	5 / 11	1
GH218BX*	Chemical Cushion Gum	.8 x 450 / 1/32 x 18	5 / 11	1

\*Item not shown

### Chemical Cure Stripping Stock

Item No.	Description	Gauge & Width (mm/inches)	Roll Weight (kg/lbs)	Box Qty.
854BX	Gray Chemical Gum	.4 x 25 / 1/64 x 1	0.5 / 1	5

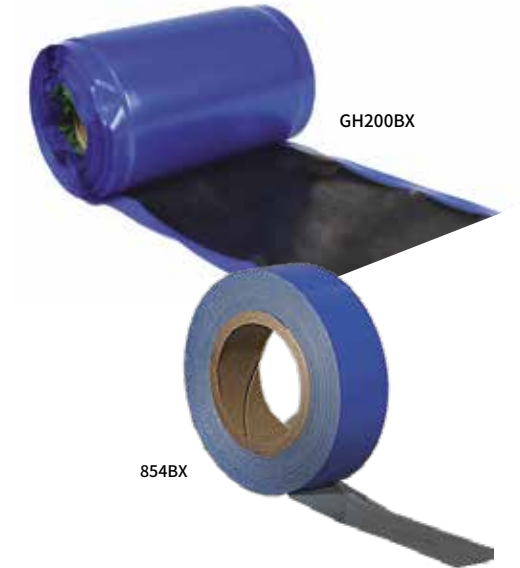

GH200BX

854BX

## TECH A & B Compound

A&B Compound is a two part self vulcanizing rubber compound for bead, spot, and section repairs. For best results, use with Tech #760 Chemical Vulcanizing Fluid or #775 Heavy Duty Blue Cement.

Item No.	Description	Can Weight (kg/lbs)	Box Qty.
857A*	A & B Strip Rubber	.5 / 1	5
857B*	A & B Strip Rubber	.5 / 1	5
858	A & B Compound	.5 / 1	1
859*	A & B Compound	.9 / 2	1

\*Item not shown



858



# TECH Permacure® Inside/Outside Reinforced Repairs & Repair Kits

- Nylon reinforced design makes applying repairs easier, virtually eliminating cutting and resulting in less labor time and a durable repair.
- TECH's unique cushion gum flows and cures into cracks and crevices, and permanently vulcanizes to the tire itself.
- Permacure II repair units are excellent for smaller injuries.
- Tech Flow-Seal Inserts are designed for demounted tires and can be used to fill an injury and are very effective when backed up with the appropriate repair unit.

## Permacure Repairs

Item No.	Description	Length	Box Qty.	Car	Truck	Motorcycle	Tractor	Earthmover
220	PERMACURE II REPAIRS	3 3/4", 95mm	50	•	•	•		
222	PERMACURE REPAIRS	3 3/4", 95mm	50	•	•	•		
224	PERMACURE TRUCK REPAIRS	5 1/8", 130mm	40				•	•
226	PERMACURE EARTHMOVER REPAIRS	7 1/2", 190mm	25				•	•



### No. 215PK Repair Kit Contains:

- No. 220/222 Combination box of Permacure repairs, contains [25] 220 Permacure II repairs and [25] 222 Permacure repairs
- No. 770 Flow-Seal Vulcanizing Fluid
- No. 911 Permacure Wrench, 2mm
- No. 915 Spiral Cement Tool
- No. 925 Permacure Tool w/Passenger Needle
- No. 926 Permacure Passenger Replacement Needle

### No. 216TK Truck Repair Kit Contains:

- No. 224 Permacure repairs
- No. 770 Flow-Seal Vulcanizing Fluid
- No. 911 Permacure Wrench, 2mm
- No. 915 Spiral Cement Tool
- No. 925T Permacure Tool w/Truck Needle
- No. 927 Permacure Truck Replacement Needle



## Permacure Repair Kits

Item No.	Description	Car	Truck	Motorcycle	Tractor	Earthmover
215PK	PERMACURE REPAIR KIT	•	•	•		
216TK	PERMACURE TRUCK REPAIR KIT		•		•	•

# TECH Flow-Seal® Inserts, Self-Vulcanizing Inside/Outside Repairs

- You can repair small injuries in tubeless tires fast and easy with TECH Flow-Seal Inserts.
- Unique gray cushion gum flows into the injury and completely seals the inner liner as well as broken cord and cable ends.
- The insert permanently vulcanizes through the injury. The tire is immediately ready for use.
- Flow-Seal inserts are ideal for use in both bias and steel belted radial tires.
- Tech Flow-Seal Inserts are designed for demounted tires and can be used to fill an injury and are very effective when backed up with the appropriate repair unit.



Item No.	Description	Length	Box Qty.	Car	Truck	Motorcycle	Tractor	Earthmover
204	ROUND INSERTS	2", 50mm	40	•	•	•		
206	OVAL INSERTS	2", 50mm	40	•	•	•		
208	ROUND TRUCK INSERTS	3 3/4", 95mm	20				•	•
209	OVAL TRUCK INSERTS	3 3/4", 95mm	40				•	•
211	ROUND INSERTS	7 1/2", 190mm	25				•	•
212	OVAL INSERTS	9", 225mm	15				•	•
217	GIANT OVAL INSERTS	8 1/4", 210mm	10				•	•

NOTE: When applying 208 and 209 inserts, the 923 truck needle must replace 921 needle which comes in a 920 Insert-O-Matic Tool.





**No. 880 Motorcycle Tubeless Tire Repair Kit:**

- No. 249UL** Uni-Seal Ultras [1 box]
- No. 250UL** Uni-Seal Ultras [1 box]
- No. 261** Uni-Seal cutter [1]
- No. 704A** Rub-O-Matic [1]
- No. 760** Chemical Vulcanizing Fluid [1]
- No. 915** Spiral Cement Tool [1]
- No. 933** Rubber Scraper [1]
- No. 935** Stitcher/buffer [1]

For shop use. Packed in a heavy-duty plastic box with handle.



**No. 896NHTK Truck Nail Hole (Tools Only) Repair Kit**

A complete kit for road service and repairing of nail holes in both radial and bias tires, with tool box. Contains:

- |   |  |
|---|--|
| <b>No. 270</b> 1/4" (6mm) Carbide Cutter [1]                            | <b>No. 911</b> Allen Wrench for Quick Adaptors [1] |
| <b>No. 271</b> 1/4" (6mm) Carbide Cutter [1]                            | <b>No. 912</b> Allen Wrench for Air Tools [1]      |
| <b>No. 271/38</b> 3/8" (10mm) Carbide Cutter [1]                        | <b>No. 913</b> Slip Joint Pliers [1]               |
| <b>No. CP873K</b> Low Speed Tire Buffer With Exhaust Kit [1]            | <b>No. 915</b> Spiral Cement Tool [1]              |
| <b>No. TRT105</b> Injury Measuring Tool [1]                             | <b>No. 919</b> Pointed Awl [1]                     |
| <b>No. S1035</b> Air Drill 500 RPM with exhaust kit and quick chuck [1] | <b>No. 933</b> Rubber Scraper [1]                  |
| <b>No. S1040</b> Quick Change Adaptor for 270 carbide cutter [1]        | <b>No. 939</b> 1/4" (6mm) Stitcher [1]             |
| <b>No. S1041</b> Quick Change Adaptor for 271 carbide cutter [1]        | <b>No. 940</b> Skiving Knife [1]                   |
| <b>No. S1041/38</b> Quick Change Adaptor for 271/38 carbide cutter [1]  | <b>No. 973</b> Chrome Vanadium Diagonal Pliers [1] |
| <b>No. S1047</b> Quick Change Adaptor [2]                               | <b>No. S923</b> Safety Glasses [1]                 |
| <b>No. TECHS892</b> 3" (75mm) Soft Wire Brush [1]                       | <b>No. RM-4</b> Repair Manual [1]                  |
| <b>No. RH107</b> Flared Buffing Wheel [1]                               | <b>No. RM-5</b> Repair Manual [1]                  |
| <b>No. RH152</b> Flared Buffing Wheel [1]                               | <b>No. ODEC5</b> 5 1/2" Oval Decal [1]             |
| <b>No. 896</b> Plastic Tool Box [1]                                     |  |



**Performance Tire Kit**

**No. 898 Performance Tire Kit**

A complete kit for Uni-Seal repair of speed rated tire injuries from 1/8" (3mm) to 1/4" (6mm), with tool box. Contains:

- |  |  |
|--|--|
| <b>No. 249UL</b> Uni-Seal Ultras [1 box]                                 | <b>No. 933</b> Rubber Scraper [1]                  |
| <b>No. 250UL</b> Uni-Seal Ultras [1 box]                                 | <b>No. 936</b> 1/8" (3mm) Stitcher [1]             |
| <b>No. 269</b> 1/8" (3mm) Carbide Cutter [1]                             | <b>No. 951</b> White Paint Sticks, 12 pack [1 box] |
| <b>No. 270P</b> 1/4" (6mm) Carbide Cutter [1]                            | <b>No. S923</b> Safety Glasses [1]                 |
| <b>No. TRT105</b> Injury Measuring Tool [1]                              | <b>No. TK</b> Knife [1]                            |
| <b>No. 704A</b> Rub-O-Matic aerosol [1]                                  | <b>No. RM-4</b> Repair Manual [1]                  |
| <b>No. 738</b> Security Coat [1]   | <b>No. 111TM</b> Repair Template [1]               |
| <b>No. 760</b> Chemical Vulcanizing Fluid [1]                            |  |
| <b>No. S1032</b> Air Buffer 2,600 RPM with exhaust kit & quick chuck [1] |  |
| <b>No. S1040</b> Quick Change Adaptor for 270 carbide cutter [1]         |  |
| <b>No. S1043</b> Quick Change Adaptor for 269 carbide cutter [1]         |  |
| <b>No. S1046</b> Quick Change Adaptor for S893 and S2027 [2]             |  |
| <b>No. S893</b> 1 1/2" (40mm) texture brush [1]                          |  |
| <b>No. RH140</b> Contour Wheel [1]                                       |  |
| <b>No. 910</b> Cement Tool [1]   |  |
| <b>No. 911</b> Allen Wrench for Quick Adaptors [1]                       |  |
| <b>No. 913</b> Slip Joint Pliers [1]                                     |  |
| <b>No. 915</b> Spiral Cement Tool [1]                                    |  |



**Truck Nail Hole Repair Kit**

**No. 896 Truck Nail Hole Repair Kit**

A complete kit for road service and repairing of nail holes in both radial and bias tires, with tool box. Contains:

- |  |  |
|--|--|
| <b>No. 170</b> (CT-20) Radial Repairs [1 box]                            | <b>No. RH107</b> Flared Buffing Wheel [1]          |
| <b>No. 166</b> (CT-12HD) Radial Repairs [1 box]                          | <b>No. RH152</b> Flared Buffing Wheel [1]          |
| <b>No. ULS8</b> (251-1UL) 5/16" (8mm) Uni-Seal Stems [1 box]             | <b>No. 911</b> Allen Wrench for Quick Adaptors [1] |
| <b>No. ULS10</b> (291-1UL) 3/8" (10mm) Uni-Seal Stems [1]                | <b>No. 912</b> Allen Wrench for Air Tools [1]      |
| <b>No. 271</b> 1/4" (6mm) Carbide Cutter [1]                             | <b>No. 913</b> Slip Joint Pliers [1]               |
| <b>No. 271/38</b> 3/8" (10mm) Carbide Cutter [1]                         | <b>No. 915</b> Spiral Cement Tool [1]              |
| <b>No. TRT105</b> Injury Measuring Tool [1]                              | <b>No. 919</b> Pointed Awl [1]                     |
| <b>No. 704A</b> Rub-O-Matic aerosol [1]                                  | <b>No. 933</b> Rubber Scraper [1]                  |
| <b>No. 738</b> Security Coat [1]   | <b>No. 936</b> 1/8" (3mm) Stitcher [1]             |
| <b>No. 760</b> Chemical Vulcanizing Fluid [1]                            | <b>No. 940</b> Skiving Knife [1]                   |
| <b>No. S1032</b> Air Buffer 2,600 RPM with exhaust kit & quick chuck [1] | <b>No. 951</b> White Paint Sticks, 12 pack [1 box] |
| <b>No. S1035</b> Air Drill 500 RPM with exhaust kit and quick chuck [1]  | <b>No. S923</b> Safety Glasses [1]                 |
| <b>No. S1041</b> Quick Change Adaptor for 271 carbide cutter [1]         | <b>No. 170TM</b> Repair Template for 170 [1]       |
| <b>No. S1041/38</b> Quick Change Adaptor for 271/38 carbide cutter [1]   | <b>No. 170TM</b> Repair Template [1]               |
| <b>No. S1047</b> Quick Change Adaptor [2]                                | <b>No. RM-5</b> Repair Manual [1]                  |
| <b>No. TECHS892</b> 3" (75mm) Soft Wire Brush [1]                        |  |

# Chemicals

TECH pioneered the chemical vulcanization process over 80 years ago. TECH offers a complete range of chemicals each specially designed and engineered to work with companion TECH repair units. Use of TECH chemicals ensure that all repairs are permanent and safe. TECH's complete line of chemicals are engineered and manufactured to the highest standards. TECH has a product for virtually every tire category and every type of repair.





# TECH Mounting & Demounting Chemicals

- Provide excellent lubricity to make tire mounting and demounting easier when applied to the tire bead and rim mating surfaces.
- Petroleum free with rust inhibitors to prevent rust or corrosion.
- Silicone free so they dry tacky preventing tire and rim slippage.
- TECH Tire & Tube Mounting Compound is a vegetable oil based lubricant which can be applied with a brush or mixed with water and applied with a swab.
- TECH Tire Mounting Paste is a water based lubricant that goes on with a brush eliminating spills and slip hazards in the service area.

## TECH Mounting & Demounting Lubricants & Applicators

Item No.	Description
720	RIM EASE MOUNTING LUBRICANT, 1 gal., 3.8 liter jug
720-5G*	RIM EASE MOUNTING LUBRICANT, 5 gal., 19 liter pail
720-55G*	RIM EASE MOUNTING LUBRICANT, 55 gal., 209 liter drum
721	MOUNT-O-MATIC CONCENTRATE, 16 oz., 475ml
722	TECH TIRE & TUBE MOUNTING COMPOUND, 8 lb., 3.63kg
723*	TECH TIRE & TUBE MOUNTING COMPOUND, 25 lb., 11.34kg
783	TECH TIRE MOUNTING PASTE, 8 lb., 3.7kg
783-5E*	TECH TIRE MOUNTING PASTE, 11 lb., 5kg
784	TECH PREMIUM BLUE TIRE PASTE, 8 lb., 3.7kg
784LP*	TECH LOW PROFILE PREMIUM BLUE TIRE PASTE, 8 lb., 3.7kg
735	TECH BEAD SEALER, 32 oz., 945ml can with brush
963	PLASTIC FUNNEL, each
964	SWAB, each
971	ANGLED BRUSH, each

\*Item not shown.

## Mounting Compounds

Black Lube is applied to all interior rim surfaces and to the tire beads to prevent corrosion and simplify tire mounting and demounting.

Item No.	Description
TBP25	TECH BLACK LUBE, 25 lb., 11.5kg
TBP8	TECH BLACK LUBE, 8 lb., 3.7kg

## TECH Bead Breaker

TECH Bead Breaker is a penetrating rubber lubricant that frees stubborn beads from the rim and simplifies tire demounting.

Item No.	Description
734Q	BEAD BREAKER, 1 qt., 945ml can
734*	BEAD BREAKER, 1 gal., 3.8 liter can
734-5G*	BEAD BREAKER, 5 gal., 19 liter
734-55G*	BEAD BREAKER, 55 gal., 209 liter

\*Item not shown.



# TECH Rubber Cleaners

- TECH Rub-O-Matic is a CFC-free pre-buff cleaner which quickly and easily removes contamination from the inner liner of the tire allowing for increased repair unit adhesion and extended buffing wheel life.

Item No.	Description	Box Qty.
704	RUB-O-MATIC, 1qt., 945ml can	Ea.
704A	RUB-O-MATIC, in aerosol spray can, 11.75 oz., 336g	Ea.
704G	RUB-O-MATIC, 1 gal., 3.8 liter can	Ea.
704-5G*	RUB-O-MATIC, 5 gal., 19 liter	Ea.
704-55G*	RUB-O-MATIC, 55 gal., 209 liter	Ea.
705C	TECH CITRUS-BASED RUBBER CLEANER, 32 oz., 945ml can	Ea.
705C-5G*	TECH CITRUS-BASED RUBBER CLEANER, 5 gal., 19 liter	Ea.
975	ATOMIZER, 16 oz., 453.6g refillable sprayer	Ea.

\*Item not shown



## Other TECH Chemicals

- TECH Security Coat is a water-based formula that provides air retention to the over-buffed area after repair.
- Use TECH-CHEK to find the difficult to locate leaks.

Item No.	Description	Box Qty.
738	SECURITY COAT overbuff inner liner sealant, 16 fl. oz., 470ml	Ea.
738G	SECURITY COAT, 1 gal., 3.8 liter	Ea.
739	BUTYL LINER REPAIR SEALER, 32 oz., 945ml can with brush cap	Ea.
706-1	TIRE TALC, 1 lb., .5kg	Ea.
751	TECH-CHEK concentrate, 1 qt., 945ml bottle	Ea.
751-5G*	TECH-CHEK concentrate, 5 gal., 19 liter	Ea.
751-55G*	TECH-CHEK concentrate, 55 gal., 209 liter	Ea.
969	SPRAY BOTTLE, 16 oz.	Ea.

\*Item not shown

## TECH Tire & Wheel Service Lubricants

- TECH Precision Air Tool Oil is used daily to keep air tools working to their full potential.
- TECH's family of shop chemicals provide superior performance for tough jobs. TECH's family of shop chemicals are TECH tested and TECH approved!
- Markal EZ Break anti-seize prevents threads and metal moving parts from sticking in the most corrosive environments.

Item No.	Description	Box Qty.
753	TECH PRECISION AIR TOOL OIL, 32 oz., 945ml	Ea.
418-08907*	EZ BREAK® ANTI-SEIZE COPPER GRADE, 16 oz. 470ml, with brush cap	Ea.
418-08910*	EZ BREAK® ANTI-SEIZE, 10 oz. 294ml, with brush cap	Ea.
TPL11	TECH PENETRATING LUBRICANT, 11 oz.	Ea.
TCCC12	TECH CARB & CHOKE CLEANER, 12 oz.	Ea.
TBPC14	TECH BRAKE & PARTS CLEANER, 14 oz.	Ea.
TED18	TECH FOAMING ENGINE DEGREASER, 18 oz.	Ea.

\*Item not shown



CHEMICALS

# TECH Vulcanizing Fluids

- TECH fast-drying Chemical Vulcanizing Fluid works with both TECH gray and Thermacure cushion gums to bond tire and tube repairs in hot or cold applications.
- Heavy Duty Blue Vulcanizing Fluid is an extra thick vulcanizing fluid for hot or cold applications. Works well with single coat coverage when applying large bias or radial repairs in tubeless or tube-type tires, and for any hard gum repair applications.

Item No.	Description	Box Qty.
760	CHEMICAL VULCANIZING FLUID, 7.8 oz., 230ml can with brush cap	Ea.
761	CHEMICAL VULCANIZING FLUID, 1 qt., 945ml can	Ea.
762*	CHEMICAL VULCANIZING FLUID, 1 gal., 3.8 liter	Ea.
765**	CHEMICAL VULCANIZING FLUID, 50ml tube, box of 24	Ea.
766**	CHEMICAL VULCANIZING FLUID, 20ml tube, box of 24	Ea.
767**	CHEMICAL VULCANIZING FLUID, 10ml tube, box of 24	Ea.
768***	FLOW SEAL VULCANIZING FLUID, 8 oz., 235ml can with brush cap	Ea.
770***	FLOW SEAL VULCANIZING FLUID, 7 oz., 205ml with flip top dispenser	Ea.

\*Item not shown  
 \*\*All tubes of Tech Chemical Vulcanizing Fluid come packaged in self-merchandising display cartons. Sold in full box quantities of 24 only.  
 \*\*\*For insert use only.

Item No.	Description	Box Qty.
772	ENVELOPE VULCANIZING FLUID, 8 oz., 235ml can	Ea.
775	HEAVY DUTY BLUE VULCANIZING FLUID, 8 oz., 235ml can with brush cap	Ea.
776	HEAVY DUTY BLUE VULCANIZING FLUID, 1 qt., 945ml can with brush cap	Ea.
777*	HEAVY DUTY BLUE VULCANIZING FLUID, 1 gal., 3.8 liter	Ea.
1082	TEMVULC BLACK CEMENT for heat vulcanizing applications, 1 qt., 945ml can	Ea.
1082G	TEMVULC BLACK CEMENT, 1 gal., 3.8 liter	Ea.
1082-5G*	TEMVULC BLACK CEMENT, 5 gal., 19 liter	Ea.
1082-55G*	TEMVULC BLACK CEMENT, 55 gal., 209 liter	Ea.
968LB	ALUMINUM CEMENT DISPENSER with long brush, 1 qt., 945ml	Ea.
968RLB	REPLACEMENT LID AND BRUSH for 968LB	Ea.

\*Item not shown





# Service Tools & Equipment



TECH offers a complete range of tools and equipment designed for specific facets of tire and wheel service. Designed with the task and technician in mind, TECH equipment makes every job easier and faster. TECH's complete line of Shop Equipment and Tools are made to the highest quality standards in the industry to deliver years of excellent service and great value.



# TECH Repair Tools & Accessories

- Tech tools and accessories are made of the highest quality materials.
- Designed to make your tire repair job easier and faster.

## Probes, Awls & Packing Tools

Item No.	Description	Box Qty.
910	3" CEMENT TOOL with polypropylene handle	Ea.
915	SPIRAL CEMENT TOOL	Ea.
916	GIANT SPIRAL CEMENT TOOL	Ea.
918*	DUCK BILL AWL, 4", 100mm length	Ea.
919	POINTED AWL, 8", 200mm length (screwdriver-style handle)	Ea.

\*Item not shown

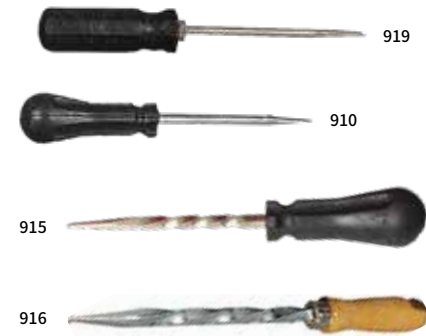

## Stitchers & Scrapers

Item No.	Description	Box Qty.
933	RUBBER SCRAPER	Ea.
935	STITCHER/BUFFER	Ea.
936	STITCHER, 1 1/2", 38mm x 1/8", 3mm	Ea.
938	STITCHER, 1 1/2", 38mm x 1/32", 0.8mm	Ea.
939	STITCHER, 2", 50mm x 1/4", 6mm	Ea.



## Insert Tools & Replacement Needles

Item No.	Description	Box Qty.
900	INSERT TOOL, 3", 75mm	Ea.
903*	STEEL T-HANDLE CUTTER	Ea.
905	HEAVY DUTY INSERT TOOL, 9", 225mm	Ea.
920	INSERT-O-MATIC TOOL	Ea.
921	PASSENGER REPLACEMENT NEEDLE	Ea.
923	INSERT-O-MATIC TRUCK NEEDLE	Ea.
925	PERMACURE PASSENGER TOOL, 2 1/8", 54mm	Ea.
926	PERMACURE PASSENGER REPLACEMENT NEEDLE	Ea.
925T*	PERMACURE TRUCK TOOL, 2 3/4", 70mm	Ea.
927*	PERMACURE TRUCK REPLACEMENT NEEDLE	Ea.
925E	PERMACURE EARTHMOVER TOOL, 6", 150mm	Ea.
928B	PERMACURE EARTHMOVER REPLACEMENT NEEDLE	Ea.

\*Item not shown

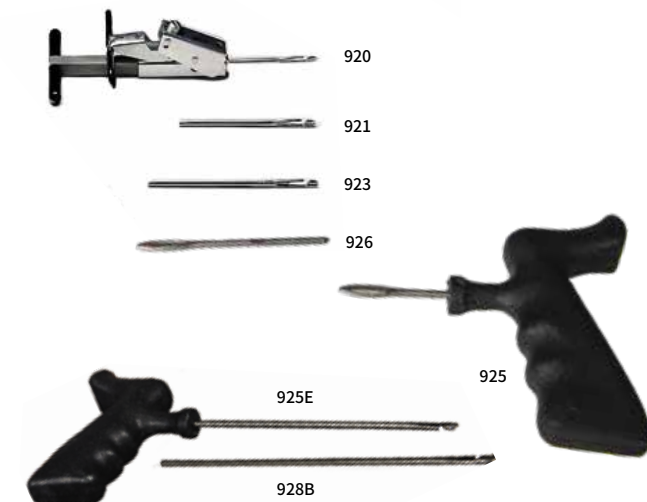

# TECH Repair Tools & Accessories

## Marking Tools



Item No.	Description	Box Qty.
949	CRAYON HOLDER, designed to fit Tech's hex tire paint marking crayons	Ea.
SIP	SILVER INK PEN, 12 per box	Ea.
946W*	MARKAL TRADES-MARKER® WHITE Mechanical Marker Pencil with 12 refills	Ea.
946Y	MARKAL TRADES-MARKER® YELLOW Mechanical Marker Pencil with 12 refills	Ea.
947W	MARKAL QUIK STIK® WHITE Mini Twist Paint Marker	12
947Y	MARKAL QUIK STIK® YELLOW Mini Twist Paint Marker	12
948	MARKAL B PAINTSTIK® WHITE Solid Paint Marker	12
948Y	MARKAL B PAINTSTIK® YELLOW Solid Paint Marker	12
951	MARKAL B PAINTSTIK® HEX WHITE Solid Paint Marker	12
951Y	MARKAL B PAINTSTIK® HEX YELLOW Solid Paint Marker	12
950	MARKAL TYRE MARQUE® YELLOW Solid Paint Crayon, marks easily on wet or cold rubber surfaces for bold, visible marks	12
950W	MARKAL TYRE MARQUE® WHITE Solid Paint Crayon, marks easily on wet or cold rubber surfaces for bold, visible marks	12
96010	MARKAL CHINA MARKER WHITE, paper wrapped grease pencil for smooth writing on most surfaces. Moisture resistant. No sharpening required.	12

\*Item not shown

## Knives & Scissors



Item No.	Description	Box Qty.
940	X2T TAPER SKIVING KNIFE	Ea.
941	X1Y EXTRA CURVE SKIVING KNIFE	Ea.
942	X3N ROUND POINT FLEXIBLE SKIVING KNIFE	Ea.
SS10	HEAVY DUTY RETREAD SCISSORS, 5", 125mm cut	Ea.



# TECH Repair Tools & Accessories

## Miscellaneous Hand Tools



Item No.	Description	Box Qty.
913	SLIP JOINT PLIERS, 8", 200mm	Ea.
973	DIAGONAL PLIERS, 6", 150mm	Ea.
931	WIRE BUFFER for rim/battery terminal	Ea.
TECH966	WHITEWALL CLEANING BRUSH with brass bristles	Ea.
TECH974	INNERLINER BRUSH with stainless steel bristles	Ea.
TRT105	COLOR CODED INJURY MEASURING TOOL	Ea.
TECH30515	WIRE WHEEL PREPARATION BRUSH	Ea.

# TECH Retreading Tools & Accessories

- Tech Electric Knife Heater is ideal to heat rubber cutting knives, shears and small tools that require heat for efficient operation.
- The Tire Brander allows retreaders and tire technicians to quickly and easily brand tires for proper identification.

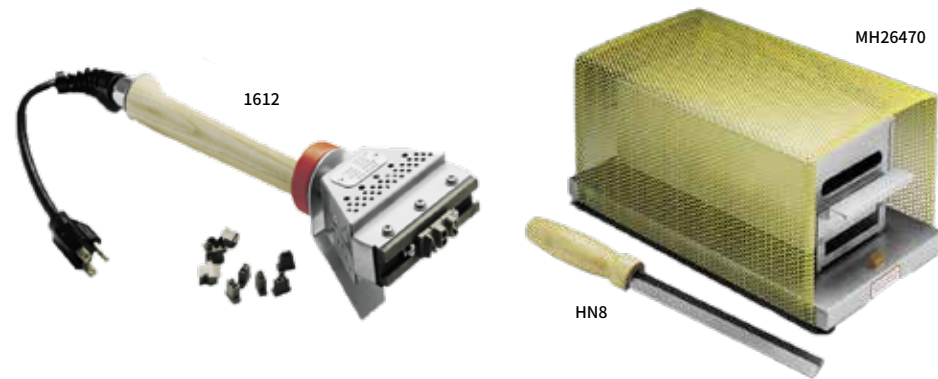

Item No.	Description
MH26470	ELECTRIC KNIFE HEATER, 115V, 350 watt rated, max. temperature 820°F, 437°C
HN8	INSULATED HEATER KNIFE, 8", 200mm blade
1612	TIRE BRANDER, 120V. (To order characters, letters and numbers, see information below)

Characters (letters and numbers) for the Brander can be ordered by using the following examples:

**Your order: 1612A**

16 = Number for Brander  
12 = 1/2" letters or numbers  
A = 1/2" letter A

**Your order: 1614A**

16 = Number for Brander  
14 = 1/4" letters or numbers  
A = 1/4" letter A

**Your order: 16148**

16 = Number for Brander  
14 = 1/4" letters or numbers  
8 = 1/4" number 8

# TECH Carbide Cutters & Carbide Burrs

- Carbide Cutters are designed to remove damaged steel cables within injuries in radial tires.
- Diamond-Cut Burrs are a quick and efficient way to remove loose wire in radial truck and bus tires when making a section repair.

## Small Carbide Cutters for Small Passenger & Light Truck Tires Only

Item No.	Description
269*	CARBIDE CUTTER, 3", 75mm length, for 1/8", 3mm injuries
270P*	CARBIDE CUTTER, 2", 50mm length, for 1/4", 6mm injuries
271P*	CARBIDE CUTTER, 3", 75mm length, for 5/16", 8mm injuries
273	TIRE BURR, 3/16" x 2" x 3"

\*1200 RPM maximum



CAUTION: Always wear eye protection.

## Carbide Cutters

Item No.	Description
270*	CARBIDE CUTTER, 3", 75mm length, for 1/4", 6mm injuries
271*	CARBIDE CUTTER, 4", 100mm length, for 5/16", 8mm injuries
271/38*	CARBIDE CUTTER, 4 9/16", 120mm length, for 3/8", 10mm injuries
272*	CARBIDE CUTTER, 5", 125mm length, for 1/2", 13mm injuries

\*1200 RPM maximum



CAUTION: Always wear eye protection.

## Diamond-Cut Burrs

Item No.	Description	Shaft Size
280	MINI POINTED CARBIDE BURR, 1 1/4", 30mm length	1/8", 3mm
282	POINTED END CARBIDE BURR, 2", 50mm length	1/4", 6mm
283	MINI-ROUTER CARBIDE BURR, 1 1/2", 40mm length	1/8", 3mm
284	ROUTER CARBIDE BURR, 2 1/2", 65mm length	1/4", 6mm
284C*	COARSE-CUT ROUTER CARBIDE BURR, 2 1/2", 65mm length	1/4", 6mm
286	BALL-SHAPED CARBIDE BURR, 2 3/4", 70mm length, 3/4", 20mm diameter	1/4", 6mm

NOTE: When using Cat. Nos. 280, 282, 283, 274C and 286, a buffer achieving 20,000 to 30,000 RPM will produce the best results.  
\*Item not shown



CAUTION: Always wear eye protection.

# TECH Tire Repair Tools

- TECH wheels and rasps feature SSG (Steel, Shot & Grit) coatings which provide a uniform surface texture for maximum adhesion.
- Flared Contour Wheels are designed so that the technician can keep a large area of the tool in contact with the tire, resulting in a more even buffed surface. 5,000 RPM maximum.



## Flared Contour Wheels

Item No.	Diameter	Width	Bore	Coating
RH100	1 3/4", 44.4mm	3/4", 19mm	3/8", 9.5mm	170 - Fine
RH102	2", 50.8mm	3/4", 19mm	3/8", 9.5mm	170 - Fine
RH104	2", 50.8mm	3/4", 19mm	3/8", 9.5mm	230 - Medium
RH107	2 1/2", 63.1mm	1 1/16", 26.9mm	3/8", 9.5mm	170 - Fine
RH109	2 1/2", 63.1mm	1 1/16", 26.9mm	3/8", 9.5mm	230 - Medium
RH111	2 1/2", 63.1mm	1 1/16", 26.9mm	3/8", 9.5mm	390 - Coarse
RH112*	3", 76.2mm	1 1/4", 31.7mm	3/8", 9.5mm	170 - Fine
OLVRH114+*	3", 76.2mm	1 1/4", 31.7mm	3/8", 9.5mm	230 - Medium
OLVRH116+*	3", 76.2mm	1 1/4", 31.7mm	3/8", 9.5mm	390 - Coarse
RH118-3/8	3 1/2", 88.9mm	1 1/2", 38.1mm	3/8", 9.5mm	170 - Fine
RH120	3 1/2", 88.9mm	1 1/2", 38.1mm	3/8", 9.5mm	230 - Medium
RH122	3 1/2", 88.9mm	1 1/2", 38.1mm	3/8", 9.5mm	390 - Coarse

+ Denotes special order item.  
\* Item not shown

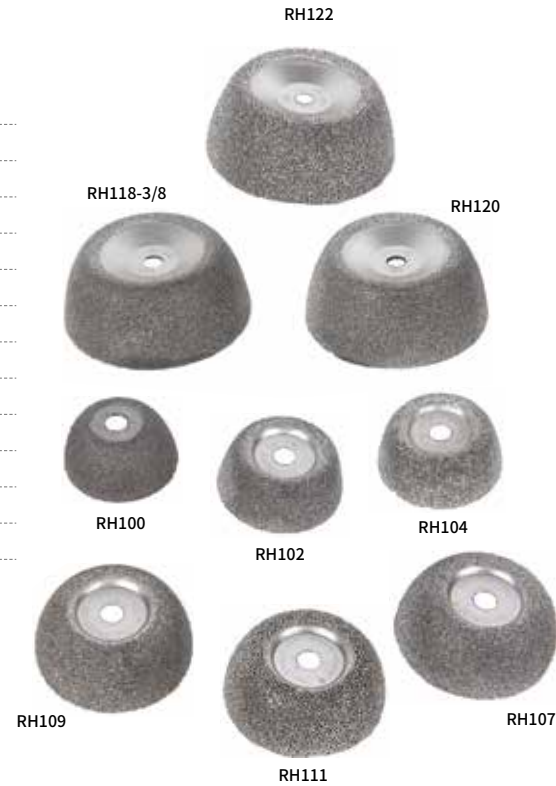

## Extreme Flared Contour Wheels

Item No.	Diameter	Width	Bore	Coating
RH122X	3 1/2", 88.9mm	1 1/2", 38.1mm	3/8", 9.5mm	Extreme 90 - Coarse
RH116X	3", 76.2mm	1 1/4", 31.7mm	3/8", 9.5mm	Extreme 90 - Coarse
RH114X	3", 76.2mm	1 1/4", 31.7mm	3/8", 9.5mm	Extreme 70 - Medium
RH120X	3 1/2", 88.9mm	1 1/2", 38.1mm	3/8", 9.5mm	Extreme 70 - Medium
S20270*	2", 50.8mm	3/4", 19mm	3/8", 9.5mm	60 - Fine

\* Item not shown

## Low-Profile Buffing Wheel

Unique design allows buffing in low profile tires without risking sidewall damage.

Item No.	Diameter	Width	Bore	Coating
RH140	1 1/4", 31.7mm	3/4", 19mm	3/8" - 24 Thread	170 - Fine



# TECH Tire Repair Tools

- Buffs cooler, no scorching
- Fantastic wear life, costing you less per repair
- Better surface texture for a safer bond
- Faster material removal, for a quicker repair

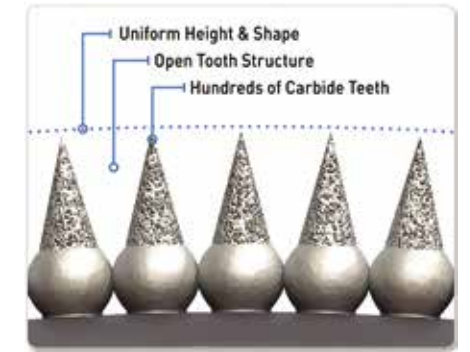

## Poly Plugs For Flared Contour Wheels

Poly Plugs easily fit inside Contour Wheels, compensating for mounting inaccuracies. Reuseable Poly Plugs improve wheel life and reduce vibration for smoother, quieter, more comfortable operation.

Item No.	Diameter	Bore
RH150*	1", 25.4mm	3/8", 9.5mm
RH151*	2", 50.8mm	3/8", 9.5mm
RH152	2 1/2", 63.1mm	3/8", 9.5mm
RH154	3", 76.2mm	3/8", 9.5mm
RH156	3 1/2", 88.9mm	3/8", 9.5mm

\*Item not shown



## Buzzout Wheels

With a fully-rounded profile, buzzout wheels are free cutting and long lasting. Buzzout wheels are excellent for bias tires, and used for skiving on high-tread radial tires. Not recommended for contact with steel cord.

Item No.	Diameter	Width	Bore	Coating
RH300	2", 51.8mm	1/4", 6.3mm	3/8" - 24 Thread	230 - Medium
RH302	2", 51.8mm	1/4", 6.3mm	3/8" - 24 Thread	390 - Coarse
RH304	2", 51.8mm	3/8", 9.5mm	3/8" - 24 Thread	230 - Medium
RH306	2", 51.8mm	3/8", 9.5mm	3/8" - 24 Thread	390 - Coarse
RH308	2", 51.8mm	1/2", 12.7mm	3/8" - 24 Thread	230 - Medium
RH310	2", 51.8mm	1/2", 12.7mm	3/8" - 24 Thread	390 - Coarse
RH312	2", 51.8mm	3/4", 19mm	3/8" - 24 Thread	230 - Medium
RH314	2", 51.8mm	3/4", 19mm	3/8" - 24 Thread	390 - Coarse

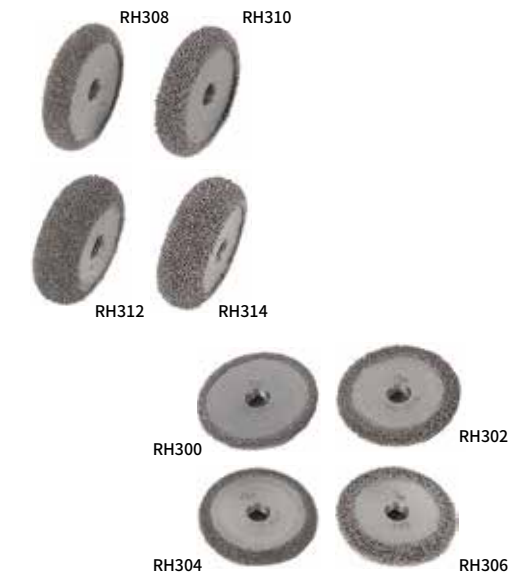

## Tapered Cones, Balls, Pencil Rasp, Rotor Saw, 1/4" Shaft

Item No.	Shape	Diameter	Head Length	Coating
RH601	Sphere	5/8", 15.8mm	5/8", 15.8mm	330 - Coarse
RH603	Sphere	7/8", 22.2mm	7/8", 22.2mm	330 - Coarse
RH605*	Sphere	1 1/8", 28.5mm	1 1/8", 28.5mm	330 - Coarse
RH611	Taper	5/8", 15.8mm	1", 25.4mm	330 - Coarse
RH613	Taper	7/8", 22.2mm	1 1/4", 31.7mm	330 - Coarse
RH619	Rotor Saw	1 3/8", 34.9mm	1/4", 6.3mm	330 - Coarse
RH626	Nail Hole Reamer	1/4", 6.3mm	3", 76.2mm	330 - Coarse

\*Item not shown





# TECH Tire Repair Tools

## Retreading Sidewall Wheels

Item No.	Shape	Diameter	Head Length	Coating
OLVRH707-50+	Donut Wheel	6", 152.4mm	1", 25.4mm	460 - Med. Coarse
RH708	Donut Wheel	6", 152.4mm	1", 25.4mm	390 - Coarse
OLVRH708-50+	Donut Wheel	6", 152.4mm	1", 25.4mm	390 - Coarse

Item No.	Diameter	Width	Bore	Coating
RH129P*	4", 101.6mm	1 1/2", 38.1mm	3/4", 19mm	390 - Coarse
OLVRH1160-390*	7", 177.8mm	-	7/8", 22.2mm	390 - Coarse

+Denotes special order item.  
\*Item not shown



## Extreme Sidewall Wheels

Item No.	Diameter	Width	Bore	Coating
RH1160XV*	7", 177.8mm	-	7/8", 22.2mm	Extreme 120 - Very Coarse

\*Item not shown

## 4-Piece 1/8" Shaft Repair Kit

Item No.	Shape	Diameter	Head Length	Coating
RH635	Long Taper	1/8", 3.1mm	3/4", 19mm	170 - Fine
	Short Taper	1/4", 6.3mm	1/2", 12.7mm	170 - Fine
	Sphere	3/8", 9.5mm	3/8", 9.5mm	170 - Fine
	Rotor Saw	3/4", 19mm	1/8", 3.1mm	170 - Fine



## Radial Skive Brushes

Item No.	Description
TECHRSB3	RADIAL SKIVE BRUSH, 3", 75mm diameter, fits 1/2", 13mm or 3/8", 10mm arbors
TECHRSB3E	PLASTIC ENCAPSULATED BRUSH, same as RSB3
S1046D*	DUAL QUICK CHANGE ADAPTOR, 3/8", 10mm diameter

\*Item not shown



## Rotary Knife Blades

Item No.	Diameter	Bore	Coating
RH100GEG-134-80+	6", 152.4mm	1 3/4", 44.4mm	80 Grit
RH100GEG-138-80+	6", 152.4mm	1 3/8", 34.9mm	80 Grit
RH100GEG-200-80+	6", 152.4mm	2", 50.8mm	80 Grit

+Denotes special order item.

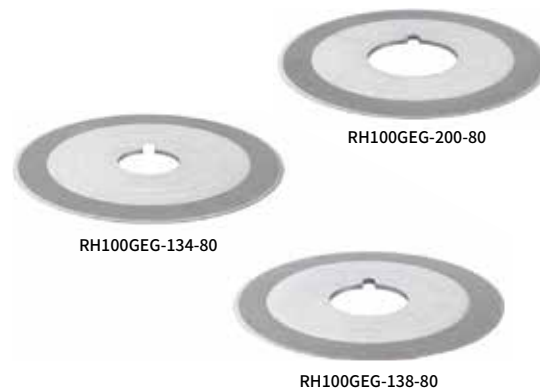

# TECH Buffing Wheels, Tungsten Carbide Rasps & Cups

- TECH tungsten carbide buffing wheels and cups have an aircooled design which permits faster, cooler and cleaner buffing and helps eliminate the burning of rubber.

## Wheels



Item No.	Description
S1009	BC-2 WHEEL, a 2", 50mm diameter wheel for tube repairs and light work. 5000 RPM max.
S1011	BC-1 WHEEL, a 2 1/2", 65mm diameter wheel for tube repairs and light work. 5000 RPM max.
S1011-1	TWO BC-1 WHEELS (S1011) placed back-to-back with S1049 threaded arbor adaptor. 5000 RPM max.
S2032	NO. 60 HB NICKEL CHROMIUM BUFFING WHEEL designed to outlast copper colored wheels. For texturizing of tubes and innerliners. 2 1/2", 65mm diameter, 3/8", 10mm arbor hole. 5000 RPM max.

## Round Faced Rasps



Item No.	Ø or Length	Width	Hole	Grit
S2000	2", 50mm	1/4", 6mm	3/8"- 24 Thread	16
S2001	2", 50mm	1/4", 6mm	3/8"- 24 Thread	36
S2002	2", 50mm	1/2", 13mm	3/8"- 24 Thread	16
S2003	2", 50mm	1/2", 13mm	3/8"- 24 Thread	36
S2004	2", 50mm	3/4", 20mm	3/8"- 24 Thread	16
S2005	2", 50mm	3/4", 20mm	3/8"- 24 Thread	36
S2204	2", 50mm	1/8", 3mm	3/8"- 24 Thread	16

The maximum speed for items S2000 through S2204 is 5000 RPM.

## Pencil Rasps, Tapered Cone Rasps



Item No.	Ø or Length	Width	Hole	Grit
S2006	2 1/2", 65mm	1/4", 6mm	—	16
S2007	2 1/2", 65mm	1/4", 6mm	—	36
S2008	4", 100mm	3/4", 20mm	3/8"- 24 Thread	16
S2009	4", 100mm	3/4", 20mm	3/8"- 24 Thread	36
S2010	2", 50mm	1", 25mm	3/8"- 24 Thread	16
S2011	2", 50mm	1", 25mm	3/8"- 24 Thread	36

The maximum speed for items S2006 through S2011 is 5000 RPM.

## Contour Cups



Item No.	Ø or Length	Width	Hole	Grit
S2020	3", 75mm	1 1/2", 40mm	3/8", 10mm	36
S2021	3", 75mm	1 1/2", 40mm	3/8", 10mm	60
S2022	4", 100mm	1 1/2", 40mm	1/2", 13mm	36
S2023*	4", 100mm	1 1/2", 40mm	1/2", 13mm	60
S2027	2", 50mm	3/4", 20mm	3/8", 10mm	60

The maximum speed for items S2020 through S2027 is 5000 RPM.

The use of an S2047 (page 45) is necessary when using S2022 and S2023 with quick change adaptors.

S2027 designed with non-aggressive grit for passenger tire inner liner and tube buffing.

\*Item not shown

## TECH Wire Brushes

- TECH's encapsulated wire brushes are a critical component to performing section repairs.
- Can be used to remove rubber surrounding steel cables, allowing damage steel to be removed without creating excess scorch.
- Brushes are ideal for cleaning buffed surfaces and skives.

### Encapsulated Wire Brushes



Item No.	Description
TECHS890	POLYURETHANE ENCAPSULATED BRUSH to remove rubber around steel cables. 2", 50mm diameter, 5,000 rpm max. 1/2", 13mm arbor hole with 3/8", 10mm reducer.
TECHS891	POLYURETHANE ENCAPSULATED BRUSH to remove rubber around steel cables. 3", 75mm diameter, 5,000 rpm max. 1/2", 13mm arbor hole with 3/8", 10mm reducer.
S897	RUBBER ENCAPSULATED BRUSH to remove rubber around steel cables. 2", 50mm diameter, 5,000 rpm max. 1/2", 13mm arbor hole with 3/8", 10mm reducer.
S898	RUBBER ENCAPSULATED BRUSH to remove rubber around steel cables. 3", 75mm diameter, 5,000 rpm max. 1/2", 13mm arbor hole with 3/8", 10mm reducer.

### Wire Brushes



Item No.	Description
TECHS892	TEXTURE BRUSH, contains (2) 3", 75mm brushes and (2) 2", 50mm flat washers to keep bristles firm. 5,000 rpm max.
TECHS893	SOFT WIRE TEXTURE BRUSH, 1 1/2", 40mm diameter. Ideal for cleaning buffed surfaces in passenger tire nailhole repairs and feathering loose inner liners. 5,000 rpm max.
TECHS894	RIM CLEANING BRUSH, 2", 50mm. 5,000 rpm max.
TECHS896	SKIVE BRUSH removes scorched rubber in injury channel. 1/2", 13mm, .005 wire. 5,000 rpm max.

## TECH Buffing Stones

- Buffing stones are recommended for buffing the inside of tires with very little rubber covering body cord material.
- These stones produce the desired texture without damaging exposed fabric.

### Buffing Stones

Item No.	Description
S946	BUFFING STONE, 4" x 1 1/4", 100mm x 30mm, 46 grit, 1/2", 13mm arbor hole, 4,200 rpm max.
S947	BUFFING STONE, 3" x 1 1/4", 75mm x 30mm, 46 grit, 3/8", 10mm arbor hole, 5,000 rpm max.



### Aluminum Oxide Stones

Item No.	Description	Max RPM
S870	MINI-PENCIL STONE, 7/16", 10.5mm, mounted on a 1/8", 3mm shaft	30,000
S872	PENCIL STONE, 1 1/16", 25mm long, 5/16", 8mm width	47,000
S872S*	SMALL PENCIL STONE, 1 1/16", 25mm long, 1/4", 6mm width	47,000
S873	MUSHROOM STONE, 1 5/8", 40mm diameter, mounted on a 1/4", 6mm shaft	23,500
S874	MINI MUSHROOM STONE, 1/2", 13mm x 1/4", 6mm, mounted on a 1/8", 3mm shaft	30,000
S875	CONICAL STONE, 1 1/8", 20mm x 3/4", 20mm wide mounted on a 1/4", 6mm shaft	33,500
S879	MUSHROOM STONE, 1 1/4", 30mm diameter, mounted on a 1/4", 6mm shaft	30,500

CAUTION: Always wear eye protection.

## TECH Rotary Gouges

- Lightweight construction and cooler running design enhances the performance and life of these rubber cutting gouges.
- The razor-like surface quickly removes large quantities of rubber.
- Fast and easy rubber removal design minimizes operator fatigue and permits better control.

Item No.	Description
S2040	ROTARY GOUGE, 2", 50mm diameter, 1/2", 15mm arbor hole. 1 per box
S2042	THIN WALL ROTARY GOUGE, 2", 50mm diameter, 3/8", 10mm arbor hole, no notch. 2 per box
S2043	THIN WALL ROTARY GOUGE, 2", 50mm diameter, 3/8", 10mm arbor hole, with notch. 2 per box
S2045	ROTARY GOUGE, 1 1/4", 30mm diameter, 3/8", 10mm arbor hole. 3 per box
S2046	MICRO ROTARY GOUGE, 3/4", 20mm diameter, 3/8", 10mm threaded arbor hole. 4 per box
S2047	1/2", 15mm to 3/8", 9mm REDUCER



CAUTION: Always wear eye protection.

## TECH Squiggly Tool

- Squiggly Tool replaces 2" x 3/8" and 1/2" carbide gritted wheels for fast rubber removal with less heat buildup.
- Lighter weight and easier control.

Item No.	Description
S2020-104	24 BLADES, 2 SUPPOT PLATES, 2", 50mm with 3/8", 10mm bore

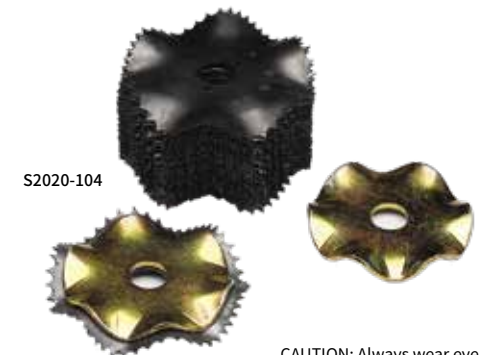

CAUTION: Always wear eye protection.

## TECH Buffing Rasps

Item No.	Description	Diameter	Width	Grit Size	Qty.
SP204/16	FLAT FACE RASP	2"	3/16"	16	Ea.
SP208/16	FANNED FACE RASP	2"	1/2"	16	Ea.
SP208/36*	FANNED FACE RASP	2"	1/2"	36	Ea.

\*Item not shown



## TECH Cut Off Wheels

Item No.	Description	Size	Box Qty.
TMRCW1-50+	CUT OFF WHEEL	3" x 1/16" x 3/8"	50
TMRCW5-50*+	CUT OFF WHEEL	3" x 1/32" x 3/8"	50
TMRCW10-50*+	CUT OFF WHEEL	3" x 3/32" x 3/8"	50
TMRCW15-50*+	CUT OFF WHEEL	4" x 3/32" x 3/8"	50

\*Item not shown

+Denotes special order item.

### Use With The Following Chuck Adaptors:

Item No.	Description
S1048*	DRILL CHUCK SHORT ADAPTOR, 1 1/2", 40mm. 3/8", 24 thread
S1049*	DRILL CHUCK LONG ADAPTOR, 2 3/4", 70mm. 3/8", 24 thread. Two nuts included.

\*Item not shown



TMRCW1-50



# TECH Air Tools & Accessories

## Buffers



Item No.	Description
S1032AC	LOW RPM GEAR HEAD REAR EXHAUST AIR BUFFER Ideal for preparing all rubber surfaces. Three gear head produces 2600 max. rpm at 90 psi. Complete with exhaust hose and quick change chuck.
AC-6400*+	HIGH RPM, REAR EXHAUST AIR BUFFER Excellent for preparing steel cables. 20,000 max. rpm at 90 psi. Complete with Jacobs chuck exhaust kit.
AC-6403*+	LOW RPM, GEAR HEAD REAR EXHAUST AIR BUFFER ideal for preparing all rubber surfaces. 4500 max. rpm at 90 psi. Threaded arbor 3/8", 24 thread. Optional S1037 rear exhaust kit available.
CP871	HIGH SPEED TIRE BUFFER
CP871K*+	HIGH SPEED TIRE BUFFER with exhaust kit
CP873*	LOW SPEED TIRE BUFFER
CP873K	LOW SPEED TIRE BUFFER with exhaust kit
S1036	LOW RPM GEAR HEAD REAR EXHAUST AIR BUFFER ideal for preparing all rubber surfaces. 4000 max. rpm at 90 psi. Threaded arbor 3/8", 24 thread. Optional S1037 rear exhaust kit available. Chuck and key sold separately.
S1039	HIGH RPM REAR EXHAUST AIR BUFFER excellent for preparing steel cables. 22000 max. rpm at 90 psi. Threaded arbor 3/8", 24 thread. Optional S1037 rear exhaust kit available. Chuck and key sold separately.
S1010C*	JACOBS CHUCK for S1036 and S1039
S1010K*	CHUCK KEY for S1036 and S1039
S1045*	QUICK CHANGE CHUCK for S1036 and S1039. Fits 3/8", 24 thread spindle.
SLP6550	3500 RPM HIGH TORQUE SKIVING AIR BUFFER threaded arbor 3/8" with quick chuck. Made in U.S.A.

\*Item not shown  
+Denotes special order item.

## Drills



Item No.	Description
CP9288C	12" HEAVY DUTY PISTOL DRILL, .5 hp (380W) motor, high torque, keyless chuck
S1035	500 RPM REVERSIBLE DRILL excellent for removing damaged rubber and steel. Complete with quick change chuck and exhaust kit. For use with carbide cutters 269-272, max. 90 psi.
S1037	REAR EXHAUST KIT for use with S1032, S1035, S1036, S1039 and SLP6550

\*Item not shown

# TECH Air Tools & Accessories

## Adaptors, Chucks & Accessories



Item No.	Description
S1040	QUICK CHANGE ADAPTOR for No. 270 and No. 270P carbide cutters. For use in S1045 quick change chuck.
S1041	QUICK CHANGE ADAPTOR for No. 271 and No. 271P carbide cutters. For use in S1045 quick change chuck.
S1041/38	QUICK CHANGE ADAPTOR designed to accept a No. 271/38 and No. 272 carbide cutter. (not shown) Use 912 Allen Wrench for tightening. (not shown)
S1043	1/8" QUICK CHANGE ADAPTOR permits use of tools with 1/8", 3mm shank to be adapted to S1045 chuck.
S1044	1/4" QUICK CHANGE ADAPTOR permits use of tools with 1/4", 6mm shank to be adapted to S1045 chuck.
S1046	QUICK CHANGE SHORT ADAPTOR 3/8", 24 thread. One flat washer, one nut included. 1/2", 13mm thread length.
S1046D	QUICK CHANGE ADAPTOR for RSB-3 brush. (not shown)
S1047	QUICK CHANGE LONG ADAPTOR 3/8", 24 thread. One flat washer, one nut included. 1", 25mm thread length.
S1047XL	QUICK CHANGE EXTRA LONG ADAPTOR 3/8", 24 thread. One flat washer, two nuts included. 1 3/4", 45mm thread length. For rasps, buffing wheels & brushes where extra length is required.
S1048	DRILL CHUCK SHORT ADAPTOR 3/8", 24 thread. 1 1/2", 40mm thread length. For use with S1010 drill chuck.
S1049	DRILL CHUCK LONG ADAPTOR 3/8", 24 thread. 2 3/4", 70mm thread length. Two nuts included. For use with S1010 drill chuck.

## TECH Impact Wrenches



### 1/2" Impacts

Item No.	Description	Free Speed (RPM)	Bolt Capacity (in.)	Square Drive (in.)	Max Torque (ft-lb)	Impacts Per Min.	Weight (lbs.)	Length (in.)	Air Cons. (CFM)	Rec. Hose Size (in.)	Air Inlet (in.) NPT/BSP
AC-1431	1/2" IMPACT WRENCH	9,000	1/2	1/2	800	1,600	5.7	7.2	8	3/8	1/4
AC-1431-2	1/2" IMPACT WRENCH with 2" extended anvil and grey pneumatic thin wall flip	9,000	1/2	1/2x2	800	1,600	5.7	7.2	8	3/8	1/4

### 3/4" Impacts

Item No.	Description	Free Speed (RPM)	Bolt Capacity (in.)	Square Drive (in.)	Max Torque (ft-lb) @90psi	Impacts Per Min.	Weight (lbs.)	Length (in.)	Air Cons. (CFM)	Rec. Hose Size (in.)	Air Inlet (in.) NPT/BSP
AC-1777	3/4" SUPER DUTY IMPACT WRENCH	6,500	1	3/4	1,400	1,600	7.5	8.12	8	1/2	3/8



### 1" Impacts

Item No.	Description	Free Speed (RPM)	Bolt Capacity (in.)	Square Drive (in.)	Max Torque (ft-lb) @90psi	Impacts Per Min.	Weight (lbs.)	Length (in.)	Air Cons. (CFM)	Rec. Hose Size (in.)	Air Inlet (in.) NPT/BSP
AC-1991	8" ANVIL 1" LOW WEIGHT IMPACT WRENCH	5,000	1 1/4	1 x 8	2,100	1,600	20.7	19.9	12	3/8	1/4
AC-1992	1" x 8" SUPER DUTY EXT. ANVIL IMPACT WRENCH	5,000	1 1/4	1	1,800	1,600	26	23.2	12	1/2	1/2
AC-1994	1" x 8" EXTENDED SUPER DUTY IMPACT WRENCH	4,500	1 1/4	1 x 8	2,300	1,100	35	26	16	1/2	1/2

## TECH Impact Sockets



## Quality Standards

The STEELMAN® and STEELMAN® PRO impact sockets and tools are made in our ISO-9001-2008 Certified facilities using the highest quality chrome-molybdenum alloy steel with technologically advanced equipment and superior manufacturing processes. The JS Products quality control system is a rigorous standard that is performed both at the factory during the manufacturing process and also at our state-of-the-art facility in the USA before the products are shipped to TECH. Furthermore, JS Products performs a Pre-Shipment QC inspection at the factory in addition to the ongoing internal factory

QC inspections. Once the product arrives, we perform an Incoming Quality Inspection, where a random sampling is pulled from the shipment based on a QC algorithm, and perform regular standards testing such as ASME B107.110-2012 — Socket Wrenches, Handles and Attachments, ASTM B117-11 — Standard Practice for Operating Salt Spray (Fog) Apparatus, and ASTM E18-11 — Standard Test Methods for Rockwell Hardness of Metallic Materials. This QC process ensures that the STEELMAN® and STEELMAN® PRO impact sockets and tools are the highest quality and most durable tools in the industry.



# TECH Extensions, Adaptors & Ratchets

## 1/2" Drive

### Adaptors

Item No.	Description	Drive
JS78243	Impact Universal Joint Drive	1/2"

### Extensions

Item No.	Description	Drive
JS99440	3" Extension	1/2"
JS78530	6" Extension	1/2"
JS95845	15" Extension	1/2"



## 3/4" Drive

Item No.	Description	Size	Drive
JS79375	Dr. Teeth Ratchet Handle	-	3/4"
JS79376	Dr. Impact Extension Bar	4"	3/4"
JS79377	Dr. Impact Extension Bar	8"	3/4"
JS79378	Dr. Sliding T-Bar	450mm	3/4"
JS79363	Adaptor	3/4" x 1/2"	3/4"



## 1" Drive

### Adaptors

Item No.	Description	Size	Drive
JS79364	Friction Ball Adaptor	1" x 3/4"	1"
JS79365	Pin Hole Adaptor	1" x 3/4"	1"

### Extensions

Item No.	Description	Size	Drive
JS60143	Impact Extension Bar	175mm	1"
JS60144	Impact Extension Bar	250mm	1"
JS60145	Impact Extension Bar	350mm	1"



# TECH Impact Socket Sets

## X-Thin Wall 5 Piece Flip Socket Set

Item No. JS99495



Item No.	Description	Drive	Point
JS99560	17mm x 19mm	1/2"	Hex
JS99561	19mm x 21mm	1/2"	Hex
JS99562	3/4" x 13/16"	1/2"	Hex
JS99563	7/8" x 15/16"	1/2"	Hex
JS99440	3" Extension	1/2"	Hex

## Thin Wall Wheel Removal Sets

Item No. JS99764 - Includes Storage Case  
Item No. JS99438 - Includes Wall Mount Holder



Item No.	Description	Drive	Point
JS99766	14mm	1/2"	Hex
JS99767	17mm	1/2"	Hex
JS99768	19mm	1/2"	Hex
JS99769	21mm	1/2"	Hex
JS99770	22mm	1/2"	Hex
JS99771	13/16"	1/2"	Hex
JS99772	7/8"	1/2"	Hex
JS99773	15/16"	1/2"	Hex
JS99774	1"	1/2"	Hex
JS99775	15/16"	1/2"	Hex

# TECH 1/2" Flip Sockets

## Standard Wall

Item No.	Description	Drive	Point
JS60228*	3/4" x 13/16"	1/2"	Hex
JS60229*	19mm x 21mm	1/2"	Hex

\*Item not shown

## Thin Wall

Item No.	Description	Drive	Point
JS301150*	3/4" x 13/16"	1/2"	Hex
JS301160*	19mm x 21mm	1/2"	Hex
JS97025*	18.5mm x 19.5mm	1/2"	Hex
JS60230*	21mm x 21.5mm	1/2"	Hex
JS60231*	22mm x 22.5mm	1/2"	Hex
JS60187*	21.5mm x 22.5mm	1/2"	Hex

\*Item not shown

# TECH X-Thin Wall Sockets



Item No.	Description	Drive	Point
JS79403	17mm	1/2"	Hex
JS79404	19mm	1/2"	Hex
JS79405	21mm	1/2"	Hex
JS79407	22mm	1/2"	Hex
JS79406	7/8"	1/2"	Hex
JS79408	3/4"	1/2"	Hex

## TECH 1/2" Impact Sockets

### Thin Wall Half Sizes

Item No.	Description	Drive	Point
JS97025	18.5mm x 19.5mm	1/2"	●
JS60230	21mm x 21.5mm	1/2"	●
JS60231	22mm x 22.5mm	1/2"	●
JS60187	21.5mm x 22.5mm	1/2"	●



## TECH 3/4" Impact Sockets & Sets

### Standard Metric



Item No.	Description	Size	Point	Included in JS79273	Included in JS79246	Included in JS79315	Included in JS79358
JS79359	3/4" Drive Metric Impact Socket	19mm	●			•	•
JS79247	3/4" Drive Metric Impact Socket	21mm	●		•	•	•
JS79248	3/4" Drive Metric Impact Socket	22mm	●		•	•	•
JS79362	3/4" Drive Metric Impact Socket	23mm	●			•	•
JS79249	3/4" Drive Metric Impact Socket	24mm	●		•	•	•
JS79274	3/4" Drive Metric Impact Socket	26mm	●	•		•	•
JS79250	3/4" Drive Metric Impact Socket	27mm	●	•	•	•	•
JS79316	3/4" Drive Metric Impact Socket	28mm	●			•	•
JS79275	3/4" Drive Metric Impact Socket	29mm	●	•		•	•
JS79251	3/4" Drive Metric Impact Socket	30mm	●	•	•	•	•
JS79252	3/4" Drive Metric Impact Socket	32mm	●	•	•	•	•
JS79317	3/4" Drive Metric Impact Socket	33mm	●			•	•
JS79276	3/4" Drive Metric Impact Socket	35mm	●	•		•	•
JS79253	3/4" Drive Metric Impact Socket	36mm	●	•	•	•	•
JS79277	3/4" Drive Metric Impact Socket	38mm	●	•		•	•
JS79254	3/4" Drive Metric Impact Socket	41mm	●		•	•	•
JS79318	3/4" Drive Metric Impact Socket	46mm	●			•	•
JS79319	3/4" Drive Metric Impact Socket	50mm	●			•	•
JS79375	3/4" Drive Dr. Teeth Ratchet Handle	-	●				•
JS79376	3/4" Drive Dr. Impact Extension Bar	4"	●				•
JS79377	3/4" Drive Dr. Impact Extension Bar	8"	●				•
JS79378	3/4" Drive Dr. Sliding T-Bar	450mm	●				•

## TECH 3/4" Impact Sockets & Sets

### Standard SAE



Item No.	Description	Size	Point	Included in JS79237	Included in JS79278
JS79238	3/4" Drive SAE Impact Socket	1"	●	•	•
JS79239	3/4" Drive SAE Impact Socket	1 1/16"	●	•	•
JS79240	3/4" Drive SAE Impact Socket	1 1/8"	●	•	•
JS79279	3/4" Drive SAE Impact Socket	1 3/16"	●		•
JS79241	3/4" Drive SAE Impact Socket	1 1/4"	●	•	•
JS79242	3/4" Drive SAE Impact Socket	1 5/16"	●	•	
JS79243	3/4" Drive SAE Impact Socket	1 3/8"	●	•	•
JS79244	3/4" Drive SAE Impact Socket	1 7/8"	●	•	•
JS79245	3/4" Drive SAE Impact Socket	1 1/2"	●	•	•

### Deep Metric



Item No.	Description	Size	Point	Included in JS79255	Included in JS79280
JS79256	3/4" Drive Deep Metric Impact Socket	21mm	●	•	
JS79257	3/4" Drive Deep Metric Impact Socket	22mm	●	•	
JS79258	3/4" Drive Deep Metric Impact Socket	24mm	●	•	
JS79281	3/4" Drive Deep Metric Impact Socket	26mm	●		•
JS79259	3/4" Drive Deep Metric Impact Socket	27mm	●	•	•
JS79282	3/4" Drive Deep Metric Impact Socket	29mm	●		•
JS79260	3/4" Drive Deep Metric Impact Socket	30mm	●	•	•
JS79261	3/4" Drive Deep Metric Impact Socket	32mm	●	•	•
JS79283	3/4" Drive Deep Metric Impact Socket	35mm	●		•
JS79262	3/4" Drive Deep Metric Impact Socket	36mm	●	•	•
JS79284	3/4" Drive Deep Metric Impact Socket	38mm	●		•
JS79263	3/4" Drive Deep Metric Impact Socket	41mm	●	•	



## TECH 3/4" Impact Sockets & Sets

### Deep SAE

JS79264



JS79285



Item No.	Description	Size	Point	Included in JS79264	Included in JS79285
JS79265	3/4" Drive Deep SAE Impact Socket	1"	Hex	•	•
JS79266	3/4" Drive Deep SAE Impact Socket	1 1/16"	Hex	•	•
JS79267	3/4" Drive Deep SAE Impact Socket	1 1/8"	Hex	•	•
JS79268	3/4" Drive Deep SAE Impact Socket	1 3/16"	Hex	•	•
JS79269	3/4" Drive Deep SAE Impact Socket	1 1/4"	Hex	•	•
JS79270	3/4" Drive Deep SAE Impact Socket	1 5/16"	Hex	•	•
JS79271	3/4" Drive Deep SAE Impact Socket	1 3/8"	Hex	•	•
JS79272	3/4" Drive Deep SAE Impact Socket	1 7/16"	Hex	•	•
JS79272	3/4" Drive Deep SAE Impact Socket	1 1/2"	Hex	•	•

### 3/4" Drive Wheel Service Set

Item No. JS79342

Item No.	Description	Size	Point
JS79343	3/4" Drive Budd Impact Socket	1 3/16"	Hex
JS79344	3/4" Drive Deep Impact Socket	33mm	Hex
JS79272	3/4" Drive Deep Impact Socket	1 1/2"	Hex
JS79345	3/4" Drive Impact Socket	7/8"	Hex
JS79346	3/4" Drive Impact Socket	15/16"	Hex
JS79238	3/4" Drive Impact Socket	1"	Hex
JS79279	3/4" Drive Impact Socket	1 3/16"	Hex
JS79347	3/4" Drive Thin Wall Deep Impact Socket	1 1/16"	Hex
JS79348	3/4" Drive Thin Wall Deep Impact Socket	1 1/8"	Hex
JS79349	3/4" Drive Thin Wall Deep Impact Socket	1 1/4"	Hex

JS79342



### 3/4" Drive Combination Budd Wheel Set

Item No. JS79326

Item No.	Description	Size	Point
JS79327	3/4" Drive Combo Budd Wheel Impact Socket	35mm x 17mm	Hex
JS79328	3/4" Drive Combo Budd Wheel Impact Socket	38mm x 20mm	Hex
JS79329	3/4" Drive Combo Budd Wheel Impact Socket	41mm x 19mm	Hex
JS79330	3/4" Drive Combo Budd Wheel Impact Socket	41mm x 21mm	Hex
JS79331	3/4" Drive Combo Budd Wheel Impact Socket	1 1/2" x 13/16"	Hex

JS79326



## TECH 1" Drive Sockets & Sets

### Standard Metric

Item No. JS79305

Item No.	Description	Size	Point
JS79306	1" Drive Metric Impact Socket	27mm	Hex
JS79307	1" Drive Metric Impact Socket	30mm	Hex
JS79308	1" Drive Metric Impact Socket	32mm	Hex
JS79309	1" Drive Metric Impact Socket	35mm	Hex
JS79310	1" Drive Metric Impact Socket	36mm	Hex
JS79311	1" Drive Metric Impact Socket	38mm	Hex
JS79312	1" Drive Metric Impact Socket	41mm	Hex
JS79313	1" Drive Metric Impact Socket	46mm	Hex
JS79314	1" Drive Metric Impact Socket	50mm	Hex

JS79305



### Standard SAE

Item No. JS79295

Item No.	Description	Size	Point
JS79296	1" Drive SAE Impact Socket	1"	Hex
JS79297	1" Drive SAE Impact Socket	1 1/8"	Hex
JS79298	1" Drive SAE Impact Socket	1 1/4"	Hex
JS79299	1" Drive SAE Impact Socket	1 3/8"	Hex
JS79300	1" Drive SAE Impact Socket	1 1/2"	Hex
JS79301	1" Drive SAE Impact Socket	1 5/8"	Hex
JS79302	1" Drive SAE Impact Socket	1 3/4"	Hex
JS79303	1" Drive SAE Impact Socket	1 7/8"	Hex
JS79304	1" Drive SAE Impact Socket	2"	Hex

JS79295



### Deep Metric

Item No. JS79287

Item No.	Description	Size	Point
JS79288	1" Drive Deep Metric Impact Socket	24mm	Hex
JS79289	1" Drive Deep Metric Impact Socket	27mm	Hex
JS79290	1" Drive Deep Metric Impact Socket	30mm	Hex
JS79291	1" Drive Deep Metric Impact Socket	32mm	Hex
JS79292	1" Drive Deep Metric Impact Socket	33mm	Hex
JS79293	1" Drive Deep Metric Impact Socket	36mm	Hex
JS79294	1" Drive Deep Metric Impact Socket	38mm	Hex

JS79287



# TECH 1" Drive Sockets & Sets

## Metric Thin Wall Socket Truck Set

Item No. JS79350

Item No.	Description	Size	Point
JS79351	1" Drive Thin Wall Deep Impact Socket (Truck)	30mm	●
JS79352	1" Drive Thin Wall Deep Impact Socket (Truck)	32mm	●
JS79353	1" Drive Thin Wall Deep Impact Socket (Truck)	33mm	●
JS79354	1" Drive Thin Wall Deep Impact Socket (Truck)	35mm	●
JS79355	1" Drive Thin Wall Deep Impact Socket (Truck)	36mm	●
JS79356	1" Drive Thin Wall Deep Impact Socket (Truck)	38mm	●
JS79357	1" Drive Thin Wall Deep Impact Socket (Truck)	41mm	●



## 1" Drive Wheel Service Set

Item No. JS79332

Item No.	Description	Size	Point
JS79333	1" Drive Budd Impact Socket	13/16"	●
JS79334	1" Drive Deep Impact Socket	33mm	●
JS79335	1" Drive Deep Impact Socket	1 1/2"	●
JS79336	1" Drive Impact Socket	7/8"	●
JS79337	1" Drive Impact Socket	15/16"	●
JS79296	1" Drive Impact Socket	1"	●
JS79338	1" Drive Impact Socket	1 3/16"	●
JS79339	1" Drive Thin Wall Deep Impact Socket	1 1/16"	●
JS79340	1" Drive Thin Wall Deep Impact Socket	1 1/8"	●
JS79341	1" Drive Thin Wall Deep Impact Socket	1 1/4"	●



## 1" Drive Combination Budd Wheel Set

Item No. JS79320

Item No.	Description	Size	Point
JS79321	1" Drive Combo Budd Wheel Impact Socket	35mm x 17mm	●
JS79322	1" Drive Combo Budd Wheel Impact Socket	38mm x 19mm	●
JS79323	1" Drive Combo Budd Wheel Impact Socket	38mm x 20mm	●
JS79324	1" Drive Combo Budd Wheel Impact Socket	41mm x 20mm	●
JS79325	1" Drive Combo Budd Wheel Impact Socket	1 1/2" x 1 3/16"	●



# TECH Specialty Socket Sets

## 16 Piece Locking Lug Master Key Set

Item No. JS78537

Item No.	Description	Size	Shape
JS78538	5-Spline Small Diameter Socket	5/8" Inner Diameter	○
JS78539	6-Spline Small Diameter Socket	41/64" Inner Diameter	○
JS78540	6-Spline Small Diameter Socket	45/64" Inner Diameter	○
JS78541	High Tech Fluted Hex Lug	12mm Outer Dimension	⊗
JS78542	High Tech Hex Lug	12mm Outer Dimension	●
JS78543	High Tech Hex Lug	15mm Outer Dimension	●
JS78544	7-Spline Small Diameter Socket	5/8" Inner Diameter	⊗
JS78545	7-Spline Small Diameter Socket	11/16" Inner Diameter	⊗
JS78546	7-Spline Small Diameter Socket	3/4" Inner Diameter	⊗
JS78547	8-Point Star Lug	7/16" Outer Dimension	⊗
JS78548	8-Point Star Lug	5/8" Outer Dimension	⊗
JS78549	10-Point Star Lug	1/2" Outer Dimension	●
JS78550	12-Spline Small Diameter Socket	11/16" Inner Diameter	○
JS78551	12-Spline Small Diameter Socket	13/16" Inner Diameter	○
JS78552	9-Point Star Lug	1/2" Outer Dimension	⊗
JS78553	High Tech Hex Lug	9/16" Outer Dimension	●



## Hub Cap Lock Removal Kit

Item No. JS75032

- GM hub cap lock remover
- GM sprocket hub cap lock remover
- Ford and Chrysler hub cap lock remover
- Large universal locking lug nut remover
- Large wheel cover lock remover



## 5 Piece Nylon Socket Set for Aluminum Wheels

Item No. JS95615

- Consists of the three most popular metric and the two most popular SAE sizes
- Prevents damage to lug nuts and wheels
- Will not damage or scratch chrome, powder-coat, anodized, cadmium, paint or phosphate coated fasteners
- Constructed of chrome-moly steel with polypropylene inserts

Item No.	Size
JS95615-01	17mm - Blue
JS95615-02	19mm - Gold
JS95615-03	13/16" - Purple
JS95615-04	21mm - Red
JS95615-05	3/4" - Green
JS95632	22mm - Green*



\*Item sold separately. Not included in 5 pc. kit.



# TECH Torque Wrenches

## 1/2" Drive

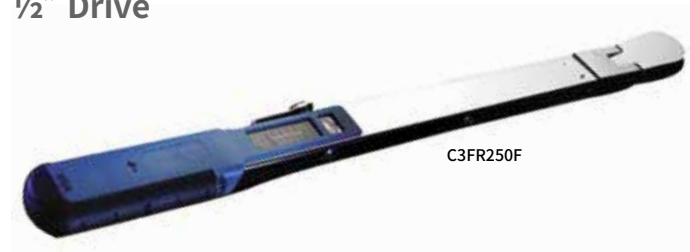

Item No.	Description	Drive	FT-LBS
C3FR250F	Flex Drive Split-Beam Click Torque Wrench	1/2"	40-250

## 3/4" Drive



Item No.	Description	Drive	FT-LBS
C4D600F	Detachable Drive Split-Beam Click Torque Wrench	3/4"	200-600
C4D600F36H*	Torque Wrench + Breaker Bar Combo Kit	3/4"	200-600

\*Item not shown.

## 1" Drive



Item No.	Description	Drive	FT-LBS
C5D600F*	Detachable Drive Split-Beam Click Torque Wrench	1"	200-600
C5D600F36H	Torque Wrench + Breaker Bar Combo Kit	1"	200-600

\*Item not shown.

# TECH Torque Extensions

## Heavy Duty Torque Limiting Impact Extensions



Item No.	Description	Drive End	Square End	Color	FT-LBS	Length (in.)	Length (mm)
JS60156	Torque Limiting Extension	3/4"	3/4"	Yellow	475	10"	254mm
JS60157	Torque Limiting Extension	3/4"	3/4"	Red	250	10"	254mm
JS60158	Torque Limiting Extension	3/4"	3/4"	Orange	175	10"	254mm
JS60159	Torque Limiting Extension	3/4"	3/4"	Purple	350	10"	254mm
JS60160	Torque Limiting Extension	3/4"	3/4"	Green	400	10"	254mm
JS60161	Torque Limiting Extension	1"	1"	Orange	175	11"	280mm
JS60162	Torque Limiting Extension	1"	1"	Red	250	11"	280mm
JS60163	Torque Limiting Extension	1"	1"	Purple	350	11"	280mm
JS60164	Torque Limiting Extension	1"	1"	Yellow	475	11"	280mm
JS60165	Torque Limiting Extension	1"	1"	Black	550	11"	280mm
JS60166	Torque Limiting Extension	1"	1"	Brown	650	11"	280mm

# TECH Air/Inflating Gauges

## Master Service Gauge & Large Bore Gauges

Item No.	Description
VH667	MASTER SERVICE GAUGE, precision instrument for testing accuracy of tire gauges and meters. Calibrated 10–20 psi in 2 lb. units
HALGA-255+	SWIVEL GAUGE designed for large bore valves. Head adjusts to fit valves with shields, right angle or straight on. 2-sided nylon bar, one side calibrated 10–150 psi in 2 lb. units. Other side kPa 80–1040.
HALGA-240+	STRAIGHT-ON PENCIL GAUGE fits large and standard bore valves. Designed to clip in shirt pocket. 4-sided nylon bar, 2 sides calibrated 20–120 psi in 2 lb. units. Other 2 sides kPa 150–800.

+Denotes special order item

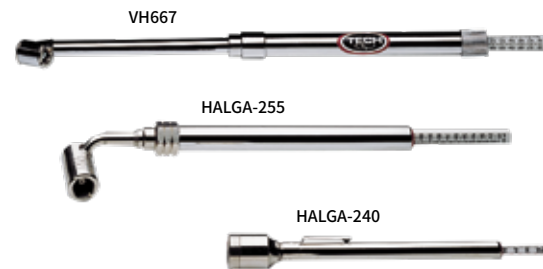

## Pocket Air Gauges

Item No.	Description
VH660	AIR LIQUID TRACTOR GAUGE for air and liquid filled tires. 4-sided nylon bar, 2 sides calibrated 10–50 psi in 1 lb. units. Other 2 sides kPa 35–310.
VHI661	STANDARD PASSENGER GAUGE, 4-sided nylon bar, 2 sides calibrated 10–50 psi in 1 lb. units. Other 2 sides kPa 75–340.
VHI662	TRUCK PENCIL GAUGE, 4-sided nylon bar, 2 sides calibrated 20–120 psi in 2 lb. units. Other 2 sides kPa 150–810.
VH663	LOW-LOW PRESSURE GAUGE, 4-sided nylon bar, 2 sides calibrated 1–20 psi in 1/2 lb. units. Other 2 sides kPa 10–135.



## Dual Foot Air Gauges

Item No.	Description
VHI664	DUAL FOOT TRUCK GAUGE, 4-sided nylon bar, 2 sides calibrated 20–120 psi in 2 lb. units. Other 2 sides kPa 150–810.
VHI665	DUAL FOOT SERVICE GAUGE, 2-sided nylon bar, one side calibrated 10–50 psi in 2 lb. units. Numbers at 10 lb. intervals. Other side kPa 80–1040.
VHI668*	STRAIGHT PUSH-ON 30° REVERSE ANGLE SERVICE GAUGE for standard bore valves. 2-sided nylon bar, one side calibrated 10–50 psi in 2 lb. units. Numbers at 10 lb. intervals. Other side kPa 80–1040.
VHI669*	STRAIGHT PUSH-ON 30° REVERSE ANGLE TRUCK GAUGE 4-sided nylon bar, 2 sides calibrated 20–120 psi in 2 lb. units. Other 2 sides kPa 150–810.

\*Item not shown.



## Inflating Gauges

Item No.	Description
VH651	HEAVY-DUTY INFLATING GAUGE, lightweight aluminum body with brass movement. 3-sided bar, 2 sides calibrated 10–120 psi in 2 lb. increments. One side kPa 70–800. 3 ft., .91m hose with clip-on air chuck. OSHA compliant.
VH651RH*	REPLACEMENT HOSE for VH651, 3 ft., .91m
VH652	HEAVY-DUTY INFLATING GAUGE, lightweight aluminum body with brass movement. 3-sided bar, 2 sides calibrated 10–120 psi in 2 lb. increments. One side kPa 70–800. 6 ft., 1.82m hose with clip-on air chuck. OSHA compliant.
VH652RH*	REPLACEMENT HOSE for VH652, 6 ft., 1.82m
VH653	HEAVY-DUTY INFLATING GAUGE, lightweight aluminum body with brass movement. 3-sided bar, 2 sides calibrated 10–120 psi in 2 lb. increments. One side kPa 70–800. 1 ft., .3048m hose with dual-foot chuck.

\*Item not shown

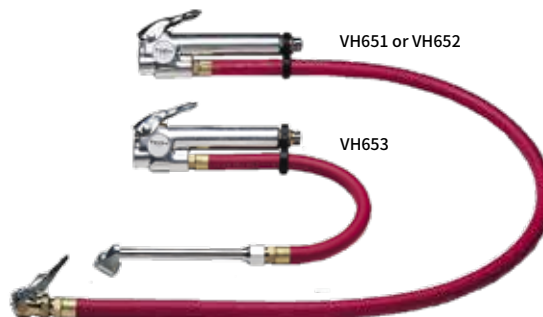

# TECH Premium Air/Inflating Gauges & Chucks

- High tech, epoxy coated black finish with silver trim that will withstand extended exposure to salt spray, harsh chemical environments, even petroleum products such as gasoline and oil.
- Features a tapered head, which guides both the air chuck and gauge over the valve stem for a direct, positive contact seal.
- Tapered head reduces air seepage from around the valve for increased accuracy.
- Airtight seal will reduce labor time by eliminating the aggravation and time spent attempting to properly inflate tires or gauge air pressure.

## Premium Dual Foot Chucks

Item No.	Description
VHIH698	PREMIUM DUAL FOOT STRAIGHT PUSH-ON 30° REVERSE ANGLE LOCK-ON CLOSED CHUCK, tapered head design for a positive valve contact. Straight-on/30° reverse angle closed chuck with threaded deep well lock nuts which lock onto valve when tilted. 1/4" female N.P.T., 6", 150mm length. Black and silver premium finish.
VHP698L	PREMIUM DUAL FOOT STRAIGHT PUSH-ON 30° REVERSE ANGLE EXTRA LONG LOCK-ON CLOSED CHUCK, tapered head design for a positive valve contact. Straight-on/30° reverse angle chuck with threaded deep well lock nuts which lock onto valve when tilted. Extra long 14", 355mm length for the difficult to reach tire valve. 1/4" female N.P.T. Black and silver premium finish.



## Premium Dual Foot Air Gauges

Item No.	Description
VHI665M	PREMIUM H.D. METAL BAR DUAL FOOT SERVICE GAUGE tapered head design to allow a precise fit when checking air pressure. 2-sided heavy-duty metal bar. One side calibrated in 10–150 psi in 2 lb. units. Numbers at 10 lb. intervals with 5 lb. marker between. Other side calibrated 80 to 1040 kPa. Metal and chrome finish.
VHIH668	PREMIUM STRAIGHT PUSH-ON 30° REVERSE ANGLE SERVICE GAUGE, tapered head design to allow a precise fit when using the straight chuck for inside dual wheels and a 30° reverse angle for outside wheels. 4-sided nylon bar. 2 sides calibrated 10–150 psi in 2 lb. units. Numbers at 10 lb. intervals with 5 lb. marker between. Other 2 sides calibrated 80–1040 kPa. Black and silver premium finish.



## Adjustable Air Gauge

Item No.	Description
HALGA-155S-RCL*	DUAL FOOT TRUCK SERVICE GAUGE

\*Item not shown.

## Air Compressors

Item No.	Description
CM031	PORTABLE AIR COMPRESSOR powered by 12 volt port in vehicle with detachable hose and safety light. 100 psi maximum.
CM030	PORTABLE AIR COMPRESSOR powered by 12 volt port in vehicle with nondetachable hose. 150 psi maximum.

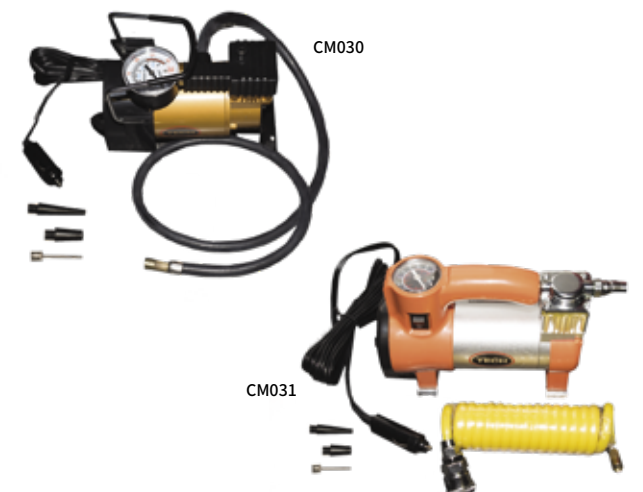



# TECH Chucks & Chuck Repair Kits

## European Style Clip-On Air Chucks

Item No.	Description
VH686*	CLOSED END EUROPEAN STYLE CLIP ON AIR CHUCK same as VH688 except has 1/4" N.P.T. female thread
VH687*	OPEN END EUROPEAN STYLE CLIP ON AIR CHUCK same as VH689 except has 1/4" N.P.T. female thread
VH688	OPEN END EUROPEAN STYLE AIR CHUCK AND CLIP for use on in-line gauges, barbed end
VH689	CLOSED CHECK EUROPEAN STYLE AIR CHUCK AND CLIP, barbed end

\*Item not shown.

## Air Chucks & Clip

Item No.	Description
VHI690	BALL FOOT AIR CHUCK, 1/4" female N.P.T.
VHI691	BALL FOOT AIR CHUCK, 1/4" female N.P.T. clip firmly locks onto valve while inflating tire
VHI692	OPEN CHECK BALL FOOT AIR CHUCK AND CLIP for use on air-line gauges, 1/4" female N.P.T.
VH694	OPEN CHECK LOCK-ON CHUCK securely locks onto valve when pushed forward. Released when sleeve is pulled back. For use on air-line gauges, 1/4" female N.P.T.
VH695	CLOSED CHECK LOCK-ON AIR CHUCK securely locks onto valve when pushed forward. Released when sleeve is pulled back. 1/4" female N.P.T.
VHJ6105	CLIP-ON AIR CHUCK for large bore. Locks on valve when clip is pushed forward. 1/4" female N.P.T.



## Dual Foot Chucks

Item No.	Description
VHI696	DUAL FOOT EXTENSION CLOSED CHUCK, for hard-to-reach valves on tractor, dual-wheel truck and bus tires, 1/4" female N.P.T., nickel plated
VHI698	DUAL FOOT STRAIGHT-ON AND 30° REVERSE ANGLE LOCK-ON AIR CLOSED CHUCK, for hard-to-reach valves on tractor, dual-wheel truck and bus tires, 1/4" female N.P.T., nickel plated
VHJ6100	RIGHT ANGLE CHUCK accepts large and standard bore valves, 1/4" female N.P.T.
VHJ6102	LARGE BORE (LONG) LOCK-ON AIR CHUCK chuck locks on valve threads, 1/4" female N.P.T.

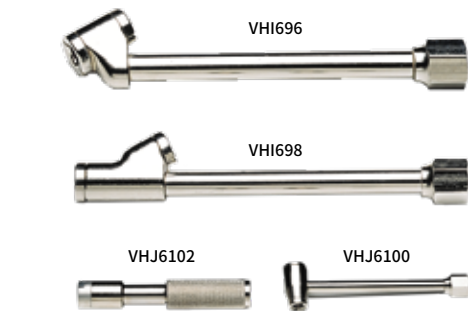

# TECH Rubber Air Hose

Tech's tough, durable EPDM rubber hose has a working pressure of 300 psi (2068 kPa). The recommended working temperature range is -40°F (-40°C) to +185°F (85°C).

Item No.	Description
RAH1225	RUBBER AIR HOSE, 1/2", 15mm x 25', 7m, with fittings
RAH1250	RUBBER AIR HOSE, 1/2", 15mm x 50', 15m, with fittings
RAH3825*	RUBBER AIR HOSE, 3/8", 10mm x 25', 7m, with fittings
RAH3850*	RUBBER AIR HOSE, 3/8", 10mm x 50', 15m, with fittings
RAH38700*	RUBBER AIR HOSE, 3/8", 10mm x 700', 213m
AMF855+*	HOSE CRIMPER HEAVY DUTY, special order (not shown)
AH440*	RUBBER AIR HOSE. Supply three air-operated air tools from a single hose. Aluminum manifold with 1/4" NPT threaded inlet, three 1/4" NPT threaded outlets

+ Denotes special order item  
\*Item not shown.



# TECH Air Couplers

## E-Z Mate Couplers

Item No.	Description
VHCEZ14	1/4" BODY, 1/4" N.P.T.
VHCEZ12	1/2" BODY, 1/2" N.P.T.



## Industrial Interchange Type

Item No.	Description
VHC15	1/4" BODY, 1/4" FEMALE N.P.T.
VHC27	1/4" NIPPLE, 1/4" MALE N.P.T.
VHC28	1/4" NIPPLE, 1/4" FEMALE N.P.T.



## Tru-Flate Type

Item No.	Description
VHC85	1/4" BODY, 1/4" FEMALE N.P.T.
VHC83	1/4" NIPPLE, 1/4" MALE N.P.T.
VHC84	1/4" NIPPLE, 1/4" FEMALE N.P.T.
HALNI-106+*	1/4" NIPPLE, Fits 302" - 32 thread (screws directly onto truck valve system)



\*Item not shown  
+Denotes special order item

## Tru-Flate Type

Item No.	Description
VHC803	3/8" BODY, 1/4" FEMALE N.P.T.
VHC809	3/8" NIPPLE, 1/4" MALE N.P.T.
VHC810	3/8" NIPPLE, 1/4" FEMALE N.P.T.



## Industrial type

Item No.	Description
VHC37*	3/8" NIPPLE, 3/8" MALE N.P.T.
VHC38*	3/8" NIPPLE, 3/8" FEMALE N.P.T.

\*Item not shown



## Aro Type

Item No.	Description
VHC75	1/4" BODY, 1/4" FEMALE N.P.T.
VHC77	1/4" NIPPLE, 1/4" MALE N.P.T.
VHC78	1/4" NIPPLE, 1/4" FEMALE N.P.T.

## Lincoln Type

Item No.	Description
VHC90	1/4" BODY, 1/4" FEMALE N.P.T.
VHC91	1/4" NIPPLE, 1/4" MALE N.P.T.
VHC92	1/4" NIPPLE, 1/4" FEMALE N.P.T.



## Tru-Flate Type

Item No.	Description
VHC805	3/8" BODY, 3/8" FEMALE N.P.T.
VHC807	3/8" NIPPLE, 3/8" MALE N.P.T.
VHC808	3/8" NIPPLE, 3/8" FEMALE N.P.T.



## Tru-Flate Type

Item No.	Description
VHC815	1/2" BODY, 1/2" FEMALE N.P.T.
VHC817	1/2" NIPPLE, 1/2" MALE N.P.T.
VHC818	1/4" NIPPLE, 1/2" FEMALE N.P.T.



SERVICE TOOLS & EQUIPMENT

# TECH Monaflex Systems Individual Components

- Extremely portable, providing the option of distortion free section repairs in a repair facility or in the most remote job site.
- Combination of flexible rubber heat pads and air bags provides the desired heat and pressure to vulcanize both rubber filler material in the damaged area and to the entire repair unit.

## Monaflex Control Panel

Monaflex OTR Control panels feature digital temperature controls, digital timers, inside and outside amp meters, air regulators and safety shut offs with an audible error alert.

Item No.	Description
MONM100	CONTROL PANEL, CAL9500 digital controls, 3 independent air lines, audible alarm
MONTRRSD*	TRRS DIGITAL DISPLAY CONTROL PANEL
MONMVS9000/615*	X PAD ADAPTER
MONMVS9000/616*	X PANEL ADAPTER

\*Item not shown



## Monaflex X-Type Heat Pads

- Cutting edge element wire design and layout.
- Improved heat pad moulding.
- Heavy duty steel conduit and cable protection moulded into the heat pad provides total cable protection.

Item No.	Description
MONMX2519H	X TYPE HEAT PAD, Bias, 25" x 19" heated surface area
MONTRX2621H	X TYPE HEAT PAD, Outside, 26" x 21" heated surface area
MONMX2626H	X TYPE HEAT PAD, Bias or outside, 26" x 26" heated surface area
MONMX3132H	X TYPE HEAT PAD, Bias, 31" x 32" heated surface area
MONMX3015H	X TYPE HEAT PAD, Radial, 30" x 15" heated surface area
MONMX4220H	X TYPE HEAT PAD, Radial, 42" x 20" heated surface area
MONMX4224H	X TYPE HEAT PAD, Radial, 42" x 24" heated surface area
MONMX4824H	X TYPE HEAT PAD, Radial, 48" x 24" heated surface area
MONMX3026H	X TYPE HEAT PAD, Radial or Bias, 30" x 26" heated surface area
MONMX4215H	X TYPE HEAT PAD, Radial, 42" x 15" heated surface area
MONTRX2213H	X TYPE HEAT PAD, Radial or Bias, 22" x 13" heated surface area
MONMX1616H	X TYPE HEAT PAD, Radial or Bias, 16" x 16" heated surface area



## Monaflex Cylinder Air Window Bag

Monaflex cylinder air bags inflate to fill out the inner cavity of the tire, providing even pressure without distortion. Cylinder Window bags are produced with a special blue elastic material that allows the bag to expand into the sidewall area of low profile and wide base tires. The bags covers are made of heat resistant nylon for strength and durability.

Item No.	Description
MONTR1315/20W	CYLINDER AIR BAG, 13" - 15" diameter, 20" barrel length
MONM1721/24W	CYLINDER AIR BAG, 17" - 21" diameter, 24" barrel length
MONM2732/32W	CYLINDER AIR BAG, 27" - 32" diameter, 32" barrel length
MONM3842/32W	CYLINDER AIR BAG, 38" - 42" diameter, 32" barrel length
MONM1721/24B	CYLINDER AIR BAG, 17" - 21" diameter, 24" barrel length
MONM2427/32	CYLINDER AIR BAG, 24" - 27" diameter, 32" barrel length
MONM2732/32WOC*	WINDOW OUTER COVER, 27" - 32" diameter, 32" barrel length

\*Item not shown



# TECH Monaflex Systems Individual Components

## Monaflex Air Bag Systems

Monaflex flat air bags are placed inside the tire with a cylinder air bag for certain tire sizes. This minimizes the number of cylinder air bags required to cover the full range of OTR tires.



Item No.	Description
MONM4824W	AIR BAG COMPLETE WITH WINDOW, 48" x 24"
MONM5432W	AIR BAG COMPLETE WITH WINDOW, 54" x 32"
MONM6732W	AIR BAG COMPLETE WITH WINDOW, 67" x 32"
MONM7532W+	AIR BAG COMPLETE WITH WINDOW, 75" x 32"

+ Denotes special order item.

## Monaflex External Curing Pack & Harness Straps

Monaflex external curing packs are produced with durable heat resistant nylon covers. The outer cover sleeve slots hold the harness straps in position and simplify equipment set up. The external curing pack provides even pressure on the outside of the tire for excellent filler rubber adhesion. Straps sold separately.

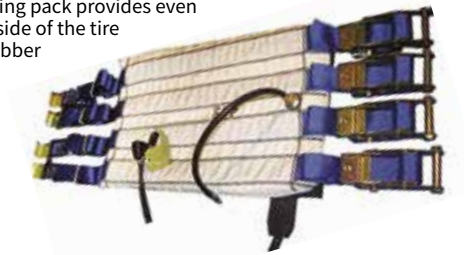

Item No.	External Curing Pack Description
MONTR2621E	26" x 21", 5 strap cover sleeve
MONM4832E	48" x 32", 6 strap cover sleeve
MONTR0CXL	Strap & buckle (5 required), used with TR2621E
MONM45/6/71HG	Harness strap set with guide, used with M4832E

# TECH Monaflex Complete OTR Vulcanizing Systems

## Monaflex OTRS Sidewall System

The Monaflex OTRS sidewall system is ideal for bias and radial spot repairs and section repairs in OTR, AG, Skidder and Flotation tire sizes from 14.00-24 to 29.5-29. This system can be completely set up on the tire in less than 3 minutes. Includes the MONMX202 control panel.

Item No.	Description
MONOSH2215	OUTSIDE HEAT PAD
MONOSH2815	INSIDE HEAT PAD
MONOS2117	OUTSIDE AIR BAG
MONOS2517	INSIDE AIR BAG
MONOTRS	COMPLETE OTR SIDEWALL SYSTEM



# TECH Monaflex Systems for Truck Tires

## MONTRDD & TRRS Systems

The TRDD and TRRS systems vulcanize repairs in radial and bias truck tire range 8.25 to 12.00-24, including low profile and super single, and 9.5-32 to 12.4-38 tractor. The less expensive TRRS covers the same radial repair sizes but is limited to 7" x 7" bias repairs. The TRDD can be extended up to 23.5 OTR tires.



## MONTRM System

TRM Machine vulcanizes radial and bias tire repairs ranging from 8.25 to 12.00, 365/80 to 445/50 super singles, 13.00 to 17.5 OTR, and 9.5-32 to 16.9-28 tractor tires. This system utilizes a steel housing and fixed outside air bag for quick and easy set up.

### TRM Replacement Parts

Item No.	Description
MONTR911/13W*	CYLINDER AIR BAG
MONTR1315/15W*	CYLINDER AIR BAG for Super Singles
MONTR2210H*	HEAT PAD
MONTR2213H*	HEAT PAD
MONM2519H*	HEAT PAD

\*Item not shown



## TECH Vulcanizing Equipment

- TECH spotters feature a platen mounted thermostat which reduces heat-up time.
- These machines offer versatility to achieve any repair of most tires, big and small, on the market.



LINT005



S1016

### Lincoln Spotters

Item No.	Description	Shipping Weight	Optional Parts
LINT003*+	TUBE PLATE SPOTTER, model 200	27 lbs. / 12kg	-
LINT148*+	ENVELOPE REPAIR SPOTTER, model ERV	54 lbs. / 25kg	-
LINT005+	PASSENGER TIRE SPOTTER, model 300	12 lbs. / 5kg	Plate Package LINT149
S1016+	TRUCK TIRE SPOTTER, model 400	14 lbs. / 6kg	Plate Package LINT150
S1016-220*+	TUBE PLATE SPOTTER, model 400, 220 volt	-	Plate Package LINT150
LINT009*+	TRACTOR TIRE SPOTTER, model 500	22 lbs. / 10kg	Plate Package LINT151
LINT011*+	LARGE TRUCK/TRACTOR TIRE SPOTTER, model 1000	30 lbs. / 14kg	Plate Package LINT152
LINT018*+	TRACTOR/TRUCK AIR SPOTTER, model 1400	36 lbs. / 16kg	Plate Package LINT154
LINT016*+	PASSENGER/LIGHT TRUCK SPOTTER, model LT	44 lbs. / 20kg	Plate Package LINT153, LINT031 Stand
LINT029*+	TRUCK TIRE BEAD SPOTTER, model 3100	38 lbs. / 17kg	-
LINT022*+	MEDIUM TRUCK TIRE SPOTTER, model MT	52 lbs. / 23kg	Plate Package LINT155, LINT031 Stand
LINT026-120*+	AIR OPERATED TRUCK SPOTTER, model 2000, 120 volt	74 lbs. / 30kg	Plate Package LINT156, LINT033 Stand
LINT026-240*+	AIR OPERATED TRUCK SPOTTER, model 2000, 240 volt	74 lbs. / 30kg	Plate Package LINT156, LINT033 Stand

\*Item not shown.  
+Denotes special order item.

## TECH Extruder Guns

- Extruder Guns are designed to fill a wide range of injuries quickly and easily without trapping air. Perfect for section repair build-up and for filling skives.
- Extruder Guns are compact, lightweight, user friendly and uses Rope Rubber or Strip Stock.

### Standard Extruders



Item No.	Description	Rubber Production	Power Rating	Electrical Resistance	Air Demand	Temperature
SAL260685S	Standard Extruder Salvadori Drive (110V)	18kg/h	750 Watt	350W 110V	12.5 lt/sec or 26.5 cfm	0-120°C or 32°F - 248°F
SAL260685-110V*	Standard Extruder Bosch Drive (110V)	18kg/h	550 Watt	350W 220V/110V	12.5 lt/sec or 26.5 cfm	0-120°C or 32°F - 248°F
SAL260685-220V*	Standard Extruder Bosch Drive (220V)	18kg/h	550 Watt	350W 220V/110V	12.5 lt/sec or 26.5 cfm	0-120°C or 32°F - 248°F
SAL260685P-110V	Standard Extruder CP Drive (110V)	15kg/h	400 Watt	350W 110V	9 lt/sec or 19 cfm	0-120°C or 32°F - 248°F
SAL260685EL	Electric Drive Extruder 550 Watt (220V)	18kg/h	550 Watt	350W 220V	-	0-120°C or 32°F - 248°F
SAL260270P-110V*	Tubeless Extruder Gun 400 Watt (110V)	-	400 Watt	350W 220V/110V	9 lt/sec or 19 cfm	0-120°C or 32°F - 248°F
SAL260270P-220V*	Tubeless Extruder Gun 400 Watt (220V)	-	400 Watt	350W 220V/110V	9 lt/sec or 19 cfm	0-120°C or 32°F - 248°F

\*Item not shown

### Magnum Extruders



SAL260686

Item No.	Description	Rubber Production	Power Rating	Electrical Resistance	Air Demand	Temperature
SAL260686	Magnum Bosch Drive Extruder 550 Watt (110V)	24kg/h	550 Watt	350W 220V/110V	12.5 lt/sec or 26.5 cfm	0-120°C or 32°F - 248°F

# TECH Extruder Guns

## Giant Extruders



Item No.	Description	Rubber Production	Power Rating	Electrical Resistance	Air Demand	Temperature
SAL260687-220V	Giant Bosch Drive Extruder 750 Watt (220V)	28kg/h	750 Watt	800W 220V/110V	13.5lt/sec or 28.5 cfm	0-120°C or 32°F - 248°F
SAL260687-110V*	Giant Bosch Drive Extruder 750 Watt (110V)	28kg/h	751 Watt	800W 220V/110V	13.5lt/sec or 28.5 cfm	0-120°C or 32°F - 248°F
SAL260687S	Giant Salvadori Drive Extruder 750W (220V)	28kg/h	550 Watt	350W 220V/110V	12.5 lt/sec or 26.5 cfm	0-120°C or 32°F - 248°F
SAL260687S110V*	Giant Salvadori Drive Extruder 750W (110V)	28kg/h	550 Watt	350W 220V/110V	12.5 lt/sec or 26.5 cfm	0-120°C or 32°F - 248°F

\*Item not shown

## Electric Extruders

Item No.	Description	Rubber Production	Power Rating	Electrical Resistance	Air Demand	Temperature
SAL260688*	Electric Drive Extruder 1600 Watt (110V)	40kg/h	1600 Watt	800W 110V	-	0-120°C or 32°F - 248°F

\*Item not shown

## A&B Strip Extruders



Item No.	Description	Rubber Production	Power Rating	Electrical Resistance	Air Demand	Temperature
SAL260683	A & B Strip Extruder Gun 1600 Watt (110V)	40kg/h	1600 Watt	800W 110V	-	0-120°C or 32°F - 248°F

# TECH Wheel Service Tools

- Wheel and Rim manufacturers and OSHA regulations state that rim mating surfaces and threads of hub and wheel assemblies must be free from rust and corrosion.
- TECH is pleased to offer new stud cleaning tools that make the job quick and easy.
- These tools have replaceable brushes and can be used with an impact wrench or drill.

## Stud Cleaning Tools

Item No.	Description	Box Qty
SBCT16	STUD CLEANING TOOL, 5/8", 16mm	1
SCBR16	REPLACEMENT BRUSH, 5/8", 16mm	1
SBCT22	STUD CLEANING TOOL, 7/8", 22mm	1
SCBR22	REPLACEMENT BRUSH, 7/8", 22mm	1
JS60099	WHEEL STUD CLEANER SET	1
JS99471*	14 PIECE HUB & ROTOR POLISHING KIT	1

\*Item not shown



## Rim Cleaning Brushes

Item No.	Description	Box Qty
931	VALVE HOLE CLEANING BRUSH	1
KEN30515	HAND HELD WIRE BRUSH	1
JS97911	BOLT BUSTER HEAT INDUCTION TOOL KIT	1



## Nut And Stud Removers

Item No.	Description	Box Qty
ESCO40100+	5 PIECE KIT, removes 3/4" and 5/8" studs, and 1 1/8" inner cap nuts	1
ESCO40107+*	BUDD INNER CAP NUT REMOVER, 1 1/8"	1
ESCO60300+	DELUXE BUDD NUT WRENCH	1
ESCO60301+	PORK CHOP STYLE CAP NUT WRENCH, 1 1/2", 38mm	1

+Denotes special order item  
\*Item not shown



CAUTION: Always wear eye protection and a mask when cleaning corroded metal surfaces.



# TECH Wheel Service Tools

## Skirt Flange Nuts for Hub Pilot Wheels

Skirt Nuts reduce tolerances between studs and bolt holes in Hub Pilot wheels to reduce vibration and improve tread wear.

Item No.	Description	Box Qty.
TSN100	M22 HEX SKIRT FLANGE NUT, 33mm	10



TSN100

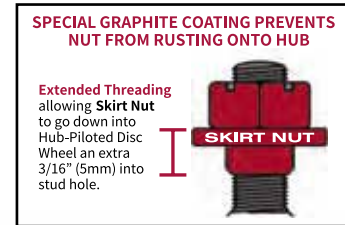
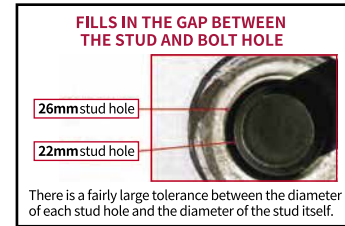

## Save-A-Stud Kits

Save-a-Stud Kits repair damaged threads on wheel studs, saving time and money. Wheel protectors prevent steel or aluminum rims from being scratched during fastener installation and removal. Save-a-Stud Kits feature a patented hinged design threaded dyes. Lifetime guarantee.

Item No.	Description	Box Qty.
ESCO30120+	8 PIECE KIT includes sizes: 7/16"- 20, 1/2"- 20, 9/16"- 18, 5/8"- 18, 12mm-1.25, 12mm-1.50, 12mm-1.75, 14mm-1.50	1
ESCO30125+	3 PIECE KIT includes sizes: 3/4"-16 right, 3/4"-16 left, 22-1.5mm	1

+Denotes special order item.



ESCO30120

ESCO30125

## Wheel Protectors

Item No.	Description	Box Qty.
990	STANDARD TOUGH POLYMER MATERIAL	1
ESCO50303+	EXTRA TOUGH MATERIAL lasts 20 times longer than standard guard	1

+Denotes special order item.



## E-Z Wheel Guards (Sold Individually)

E-Z Wheel Guards provide a thin barrier between wheel and hub mating surfaces or between dual wheels, preventing seized rims and galvanic corrosion from aluminum to steel contact.

Item No.	Hole Count	Bolt Circle	Stud Diameter	Wheel Application
ESCO60100+	10	11 1/4"	1 1/8", 7/8"	Stud Piloted
ESCO60101+	10	11 1/4"	3/4"	Stud Piloted
ESCO60102+	10	285.75mm	22mm	Hub Piloted
ESCO60104+	10	335mm	22mm	Hub Piloted
ESCO60105+	8	275mm	20mm	Hub Piloted

+Denotes special order item.



## Chrome Lug Nut Pliers

Item No.	Description	Box Qty.
KEN30606	STANDARD CHROME NUT PULLER	1
ESCO50100+	DELUXE CHROME NUT PLIERS	1

+Denotes special order item.

\*Item not shown



KEN30606

# TECH Mount/Demount Tools & Accessories

## ESCO Bead Breakers

Item No.	Description	Unit Weight
E10100	GIANT TIRE/EARTH MOVER BEAD BREAKER Use on 5-piece rims 25" to 51" with pry bar/bead loosening pockets.	31 lb.
E10101	COMBI BEAD BREAKER, works on single, two and three-piece truck tires/rims, including some new style wheels.	36 lb.
ESCO10102+	MAXI BEAD BREAKER, newly designed, works on all 3-piece wheels that replace older 5-piece wheels. Designed to work on front or back of wheel with no attachments or accessories.	38 lb.
E70160	MANUAL BEAD BREAKER	12 lb.

+Denotes special order item.



E10100

E70160

## ESCO Breaker Kits

Item No.	Description	Unit Weight
ESCO10207+	BEAD BREAKER KIT FOR E10100, contains E10100 bead breaker, ESCO10500 3.5 quart pump, hose, and all couplers and adaptors.	57 lb.
ESCO10209+	BEAD BREAKER KIT FOR E10100, contains E10100 bead breaker, ESCO10592 5 quart pump, hose, and all couplers and adaptors.	68 lb.
ESCO10200+	BEAD BREAKER KIT FOR E10101, contains E10101 bead breaker, ESCO10500 3.5 quart pump, hose, and all couplers and adaptors.	60 lb.
ESCO10202+	BEAD BREAKER KIT FOR E10101, contains E10101 bead breaker, ESCO10592 5 quart pump, hose, and all couplers and adaptors.	71 lb.

+Denotes special order item.



ESCO10202

ESCO10200

ESCO10209

ESCO10207

## ESCO Jacks

Item No.	Description	Unit Weight
E10312	LIGHTWEIGHT ALUMINUM JACK, 55 TON	33 lb.
ESCO10300+	ALUMINUM JACK, 100 TON	55 lb.

+Denotes special order item.



ESCO10300

E10312

# TECH Mount/Demount Tools & Accessories

## AME Bead Breakers

Item No.	Description	Works on Wheel Sizes	Weight lbs. / kg
AME11010+	COMBI TIRE BEAD BREAKER	Single, 2 & 3 Piece up to 25"	34 / 15.42
AME11030+	OTR 2000 GIANT TIRE BEAD BREAKER with 6" stroke	5 Piece Wheels 39"-63"	52 / 23.58

+Denotes special order item.



## Hydraulic Pumps, Hose & Couplers

Item No.	Description	Weight lbs. / kg
AME15000+	3.5 QT. TURBO II AIR HYDRAULIC PUMP 10,000 PSI / 700 Bar	16 / 7.25

+Denotes special order item.



## Lifting & Cribbing

Item No.	Description	Min. Height in. / mm	Max Height in. / mm	Weight lbs. / kg
AME13000+	100 TON ALUMINUM JACK 6" Stroke	11 3/4 / 298	17 3/4 / 451	53 / 24.04
AME15002+	STEEL CRIBBING SET 3", 6", 9"	3 / 76.2	18 / 457	141 / 63.95
AME15230+	INDUSTRIAL CRIBBING BLOCK, 6" x 7" x 24" Black	6 / 152	7 / 178	26 / 11.79
AME15260+	12 PIECE INDUSTRIAL CRIBBING SET (15230)	6 / 152	24 / 610	312 / 141.52
AME14465+	TITAN JACK PLATE with NON SKID SURFACE, 12" x 12" x 1.5"	1.5 / 38	1.5 / 38	8 / 3.62

+Denotes special order item.



## Tubeless Truck Mount/Demount Tools

Item No.	Model	Length in. / cm	Diameter in. / mm	Weight lbs. / kg
KEN34645	T45A	37 / 94	3/4 / 20	4.6 / 2.1
KEN34645C	T45AC (classic)	37 / 94	3/4 / 20	4.6 / 2.1
KEN34644	T45A-2000K	37 / 94	3/4 / 20	5 / 2.2
KEN34647	T45HD	41 / 104	7/8 / 22	7 / 3.2
KEN34747	T46A	36 / 91cm	3/4 / 20	4.5 / 2
KEN34748	T46B	36 / 91cm	3/4 / 20	4.5 / 2
KEN34749*	T46C	22 / 56	3/4 / 20	3 / 1.4
KEN34847	T47A	52 / 132	1 / 25	11 / 5
KEN34848*	T47B	49.5 / 126	1 / 25	11 / 5
KEN34849*+	T47C	27 / 69	1 / 25	6.6 / 3
KEN35449*	T2001	39 / 99	3/4 / 20	6.5 / 3

+Denotes special order item.  
\*Item not shown.



## Heavy Duty Slide Hammer

Item No.	Description	Unit Weight
E70150	QUALITY HEAVY DUTY SLIDE HAMMER handles all tubeless truck tires 16.5"-24.5" diameter	24 lb.

# TECH Mount/Demount Tools & Accessories

## Tire Mount/Demount Spoons

### Straight Spoons

Item No.	Model	Length in. / cm	Diameter in. / mm	Weight lbs. / kg
KEN32101*	T1X	18 / 46	1 1/16 / 18	1.8 / 0.8
KEN32119*	T19	24 / 61	1 1/16 / 18	2.5 / 1.1
KEN33219	T19A	30 / 61	1 1/16 / 18	3 / 1.4
KEN33238*+	T38	30 / 61	7/8 / 22	4.8 / 2.2

### Drop-Center Spoons

Item No.	Model	Length in. / cm	Diameter in. / mm	Weight lbs. / kg
KEN32121	T21R	18 / 46	1 1/16 / 18	1.8 / 0.8
KEN34121*+	T21F	24 / 61	1 1/16 / 18	2.5 / 1.1
KEN34122*+	T21HD	30 / 76	7/8 / 22	4.5 / 2

### Curved Spoons

Item No.	Model	Length in. / cm	Diameter in. / mm	Weight lbs. / kg
KEN32102*	T2X	18 / 46	1 1/16 / 18	1.8 / 0.8
KEN32120	T20	24 / 61	1 1/16 / 18	2.5 / 1.1
KEN33220*	T20A	30 / 76	1 1/16 / 18	3 / 1.4
KEN33239*	T39	30 / 76	7/8 / 22	4.5 / 2

+Denotes special order item.  
\*Item not shown.



## Blue Cobra & 19.5" Tire Mount/Demount Tools

Item No.	Model	Length in. / cm	Weight lbs. / kg
KEN35440	BLUE COBRA	54 / 1371	22 / 10
KEN33199+	19.5 TIRE IRONS (SET OF 2)	38 / 965	7 / 3.2
KEN33196+	19.5 BEAD HOLDER for Aluminum Wheels		
KEN31710+	BRASS BEAD HOLDER for Steel Wheels		
KEN31810	LEATHER WHEEL PROTECTOR		
KEN33195	19.5 TOOL SET, includes: KEN33199, KEN33196, KEN31710, KEN31810		

+Denotes special order item.  
\*Item not shown.



## Small Tire Mount/Demount Irons

Item No.	Model	Length in. / cm	Diameter in. / mm	Weight lbs. / kg
KEN39805*	T43A	15 / 38	3/4 / 20	1.8 / 0.8
KEN32106*	T6A	16.5 / 42	5/8 / 16	1.5 / 0.7
KEN32109	T9A	9 / 23	7/16 / 11	4 / 1.6
KEN32116*+	T16A	16 / 41	7/16 / 11	7 / 3





# TECH Mount/Demount Tools & Accessories

## Bead-Breaking Tools For Truck, Farm & OTR

Item No.	Model	Description	Size in. / cm	Weight lbs. / kg
KEN33341	T41	SWAN NECK LEVERAGE BAR	30 / 76	5.3 / 2.4
KEN33342	T42	30" BEAD BREAKER	30 / 76	4.8 / 2.2
KEN34652	T52	BEAD BREAKER LEVERAGE BAR	33 / 84	5.5 / 2.5
KEN32126	T26A	BEAD-BREAKING TOOL/ DRIVING IRON	11 <sup>3</sup> / <sub>4</sub> / 32	4.4 / 2



## Impact Bead Breaker, Valve Breaker & Iron Man Lifting Bar

Item No.	Model	Description	Length in. / cm	Weight lbs. / kg
KEN35924*	T24B	ECONOMY BEAD BREAKER	46 / 117	13.5 / 6.1
KEN35926	T26B	HEAVY-DUTY BEAD BREAKER	50 / 127	23 / 10.4
KEN35936*	T36B	VALVE BREAKER	45 / 115	16 / 7.3
KEN34950	T950	IRON MAN WHEEL LIFTING BAR	58 / 147	10 / 4.5

\*Item not shown.



## Lock Ring Tools

Item No.	Model	Description	Length in. / cm	Weight lbs. / kg
KEN32123	T23	TRUCK LOCK RING REMOVER	24 / 61	2.4 / 1
KEN33223	T23A	TRUCK LOCK RING TOOL	30 / 76	3.1 / 1.4
KEN33224	T23B	COMBINATION RIM/RING TOOL	23.5 / 60	2.4 / 1
KEN32125	T25	RIM LOCK TOOL	18 / 46	1.8 / 8
KEN32127	T27	SPECIAL LOCK RING TOOL	18 / 46	1.8 / 8
KEN32128*	T28	LOCK RING TOOL	18 / 46	1.8 / 8
KEN34648	T48A	HEAVY-DUTY LOCK RING TOOL	37 / 94	4.6 / 2.1

\*Item not shown.



## Gaither Tool-J1™

The J1 is a 2 piece system that mounts and dismounts all standard 19.5", 22.5" and 24.5" tubeless tires up to a 315/80R22.5, including those mounted on aluminum wheels without having to lift tire/wheel assembly.

Item No.	Description
J1	GAITHER TOOL-J1™



## Platinum Demount Tool

The Demounting Tool is a one piece tool that dismounts all standard 22.5" and 24.5" tubeless tires without having to lift the tire/wheel assembly. Includes Gaither's Handle Protector.

Item No.	Description
G12100	PLATINUM DEMOUNT TOOL
GAIG12100-1+	HANDLE GRIP

+Denotes special order item.



# TECH Mount/Demount Tools & Accessories

## Bead Saver System®

The Bead Saver System mounts and dismounts all tubeless truck tires from 17.5" up to 24.5", including all super singles.

Item No.	Description
GAI12880+	BEAD SAVER SYSTEM®

+Denotes special order item.



## Rubberhead®

Gaither's Beadkeeper is the original tool for assisting in the mounting process. Coated for protecting aluminum wheels from scratches. The blue Wide Mouth Rubberhead is available for wheels with larger flanges.

Item No.	Description
G12894-C	RUBBERHEAD
GAI12894-CW+	WIDE MOUTH RUBBERHEAD

+Denotes special order item.



## Beadkeeper®

Gaither's Beadkeeper is the original tool for assisting in the mounting process. Made of drop-forged-steel.

Item No.	Description
GAI12894+	BEADKEEPER
G12894P	KEEPERS-ON-A-ROPE—pair connected by nylon rope

+Denotes special order item.

## Duck-Billed Bead Breaking Wedges

### Wood Handled

Item No.	Model	Handle No.	Length in. / cm	Weight lbs. / kg
KEN35327	T11D	KEN35127	17 / 43	4.8 / 2.2
KEN35329	T11E	KEN35129	30 / 76	11 / 5

### Fiberglass Handled

Item No.	Model	Handle No.	Length in. / cm	Weight lbs. / kg
KEN35427	TG11D	KEN35227	18 / 46	4.8 / 2.2
KEN35429	TG11E	KEN35229	32 / 81	11 / 5
KEN35129*	T11E	-	30 / 76	1.2 / .5
KEN35229*	TG11EH	-	32 / 81	2.3 / 1

\*Item not shown.



# TECH Mount/Demount Tools & Accessories

## Tire Inflation Cages

### Portable 2-Bar Cage

Item No.	Model	Height in. / cm	Width in. / cm	Base in. / cm	Weight lbs. / kg
KEN36001	T101	41 / 104	16 / 41	7 x 21.5 18 x 55	60 / 27.2
KEN36007+*	T101A	43.5 / 111	20.5 / 52	7 x 21.5 18 x 69	72 / 32.6

### 4-Bar Cage

Item No.	Model	Height in. / cm	Width in. / cm	Base in. / cm	Weight lbs. / kg
KEN36002	T102	43.5 / 111	20.5 / 52	31.5 x 26 80 x 66	146 / 66.2

## Cap Nut Wrenches

Item No.	Model	Description	Size	Weight lbs. / kg
KEN30609	TX9	SAE PORKCHOP™ CAP NUT WRENCH	1 1/2"	.73 / .3
KEN30610+	TX10	METRIC PORKCHOP™ CAP NUT WRENCH	35mm	.4 / .1
KEN30612	TX12	METRIC PORKCHOP™ CAP NUT WRENCH	41mm	.4 / .1
KEN30620	TX50	COMBINATION SAE & METRIC	1 1/2"	1.3 / .6
KEN30618	TX200	SAE HEAVY DUTY CAP NUT WRENCH	1 1/2"	2.6 / 1.2
KEN30619	TX241	METRIC HEAVY DUTY CAP NUT WRENCH	41mm	2.6 / 1.2
KEN30165		DUAL WHEEL STUD REMOVER		1 / .5
KEN30618	TX241	HEAVY DUTY CAP NUT WRENCH	41mm	2.6 / 1.2
KEN30620	TX50	COMBINATION CAP NUT WRENCH	41mm	1.3 / .6

## Heavy Duty Tire Hammers

### Wood Handled

Item No.	Model	Handle No.	Diameter in. / mm	Weight lbs. / kg
KEN35321	T34	KEN35119	17 / 43	5.4 / 2.4
KEN35323	T35	KEN35119	16.5 / 42	6.1 / 2.7
KEN35325	T36	KEN35119	16.5 / 42	5.3 / 2.4
KEN31568	T68	KEN35119	14 / 36	1.3 / .6

### Fiberglass Handled

Item No.	Model	Handle No.	Diameter in. / mm	Weight lbs. / kg
KEN35421+*	TG34	KEN35219	18 / 46	6.1 / 2.7
KEN35423	TG35	KEN35219	18 / 46	6.6 / 3
KEN35425	TG36	KEN35219	18 / 46	6.1 / 2.7

### Replacement Rubber Head

Item No.	Model	Description
KEN35104	T11RH	RUBBER HEAD for T11R, TG11R, T33R, TG33R
KEN35105	T34R	RUBBER HEAD for T34, TG34, T35, TG35, T36, TG36

+Denotes special order item.  
\*Item not shown.



# TECH Mount/Demount Tools & Accessories

## Pneumatic Bead Breaker

- For agricultural, ATV, passenger and truck tires.
- Light weight, only 17 lbs.
- Includes blow case for storage.

Item No.	Description
GAIGTABB-01+	PNEUMATIC BEAD BREAKER

+Denotes special order item.  
\*Item not shown.



## Tire Stands

Item No.	Model	Description	Weight lbs. / kg
KEN36015	T115	TRUCK TIRE CHANGING STAND	21 / 9.5



## Passenger/ Light Truck Four-Way Lug Wrenches

Item No.	Model	Socket Sizes	Length lbs. / kg	Weight lbs. / kg
KEN35656+*	T56	17, 19, 21, 22mm	20 / 51	4 / 1.8
KEN35657	T57	3/4", 13/16", 7/8", 15/16"	23 / 58	4.5 / 2
KEN35659*	T59	3/4", 13/16", 7/8", 15/16"	22 / 56	4.2 / 1.9

+Denotes special order item.  
\*Item not shown.



## Economy Four-Way Lug Wrenches

Item No.	Model	Socket Sizes	Length in. / cm	Weight lbs. / kg
KEN35620+*	T950	3/4", 13/16", 7/8", 17mm	20 / 51	3.41 / 1.5
KEN35662+*	T62	3/4", 13/16", 7/8", 17mm	18 / 46	3.2 / 1.5
KEN35663	T63	17mm, 19mm, 21mm, 22mm	18 / 46	3.2 / 1.5
KEN35630+*		17mm, 19mm (3/4"), 21mm (13/16"), 23mm (7/8")	20 / 51	3.7 / 1.7

+Denotes special order item.  
\*Item not shown.



## Heavy-Duty Truck Lug Wrenches

Item No.	Model	Socket Sizes	Length in. / cm	Weight lbs. / kg
KEN35695	T95	1 1/16", 1 1/4", 1 1/2", 1 3/16" sq.	27.5 / 70	13.8 / 6.2
KEN35795+*	TM95	24mm, 27mm, 30mm, 33mm	27.5 / 70	13.5 / 6.1
KEN35595*	TC95	1 1/2", 1 3/16" sq., 30mm, 33mm	27.5 / 70	14.2 / 6.4
KEN35697	T95A	1 1/4", 1 1/2", 1 3/16" sq., 3/4" SERVICE ARM	27.5 / 70	13.5 / 6.1

+Denotes special order item.  
\*Item not shown.



SERVICE TOOLS & EQUIPMENT



## TECH Tire Inflation Products

- TECH Booster is designed to assist in the inflation of tubeless tires by setting the bead with a quick release of air pressure.
- Bead Bazooka™ combines the most powerful Automatic Rapid Air Release System and easiest-to-handle tank for seating tubeless tire beads.

### TECH Booster

ASME & CE certified—5 gallon tank with manual release. Powder coated inside and out.

Item No.	Description
GAIGGB-5Z	PRO 5 GALLON BOOSTER
GAIGB-5M*	5 GALLON PRO BOOSTER MIS
JS60300	5 GALLON ECO BOOSTER

\*Item not shown.

### TECH Auto Booster

ASME & CE certified—5 gallon tank with push button release. Powder coated inside and out.

Item No.	Description
GB-5ZA	TECH AUTO BOOSTER

### Bead Bazooka™ – 6 Liter

ASME, CE, TUV certified—6 litre tank with Rapid Air Release System. Powder coated inside and out.

Item No.	Description
GBB6LM	6 LITER BEAD BAZOOKA

### Bead Bazooka™ – XL 9 Liter

ASME, CE, TUV certified—9 litre tank with Rapid Air Release System. Powder coated inside and out.

Item No.	Description
GBB9LM	9 LITER BEAD BAZOOKA

## TECH Bottle Jacks

- All models have a chrome main ram and a chrome pump piston. The extension screws have a pressed thread.
- These units can be used horizontally and vertically.

Item No.	Description
TJ20B	20 TON BOTTLE JACK
TJ20BA	20 TON BOTTLE JACK AIR
TJ20BAS	20 TON BOTTLE JACK AIR SHORT



## TECH Pneumatic Jacks

- This unit includes a welded base to prolong service.
- Chrome main ram and aluminum air motor guarantee optimum lifetime.
- Air filter and air regulator connected to hose are standard.

Item No.	Description	Min. Ht. mm/in.	Max Ht. mm/in.
G432003	20 TON AIR/HYD. BOTTLE JACK ON CART	255/10.04	480/18.90

## TECH Lifting Products

- The perfect lifting choice for an extensive range of large vehicles.
- Carries a very wide hydraulic cylinder and three heavy duty wide adapters to give it stability when lifting loads that tend to shift.
- Includes official recommendation for carrying out up to a minimum of 30,000 lifts without fail.

Item No.	Description	Min. Ht. mm/in.	Max Ht. mm/in.
GAIGT-3531+	35 TON AIR SERVICE JACK	185/7.3	424/16.7

+Denotes special order item.

## TECH Floor Jacks & Jack Stands

### Floor Jacks

Two piece handle with bumper pad to help prevent damage to vehicle. Low entry height of 3 1/2" for greater access. Wide front wheels for stability. Thick side plates and reinforced lift arm for added strength/durability, and minimizes chassis torsion.

Item No.	Description	Min. Ht. mm/in.	Max Ht. mm/in.
TJ325LP	Low Profile 3.25 TON Floor Jack	3 3/4"	21 1/2"

### Jack Stands

All stands have a heavy duty robot welded frame, and multiposition ductile ratchet bar. 451205—12 ton sturdy, welded construction. Nylon wheels and removable handle. Delivered per pair.

Item No.	Description	Min. Ht. mm/in.	Max Ht. mm/in.
GAIG450301+	3 TON JACK STANDS	268/10.55	425/16.73
GAIG451600+	6 TON JACK STANDS	394/15.51	597/23.50
GAI451205+*	12 TON JACK STANDS WITH WHEELS	300/11.8	460/18

+Denotes special order item.  
\*Item not shown.

## TECH Specialty Items

Item No.	Description
GAIGTO-01TB+	O-LINE-ER for wheel stud installation
G471105HD	TIRE DOLLY for all wheels from 6.5"-24.5"
KEN34549	DUAL WHEEL SEPARATOR

+Denotes special order item.



# TECH Wheel Balancers

## Fully Automatic Laser Wheel Balancer & Diagnostic Center

- Fully automatic data entry 3D by means of lasers.
- Automatically positions the wheel at the weight placement location.
- LED to light the work space inside the rim.
- Full-time accuracy with Static unbalance always displayed on screen.
- Automatic complete diagnostic of rim, tire and wheel assembly.
- Automatic ZERO WEIGHT Lift.
- Pneumatic locking.
- Fully automatic Spotter Laser System for best correction possible (no comebacks).
- Industrial touch screen.
- Full size printer.
- Comes fully assembled.
- Made in Italy.

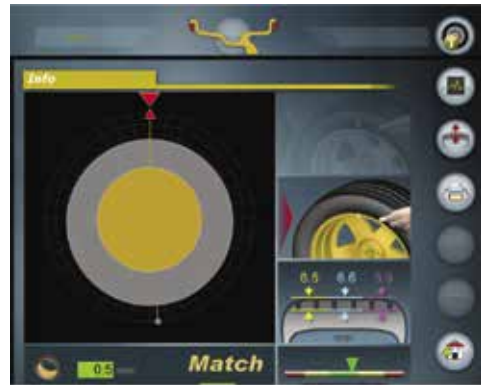

**ER100 is the only machine which can measure in 6 seconds and without any intervention of the operator:**

- Dimensions data entry
- Unbalance readings
- Wheel Runout
- Rim Runout
- Tread Depth
- Tire Conicity to identify vehicle pulls
- Direct matching between the tire and rim to reduce the Runout

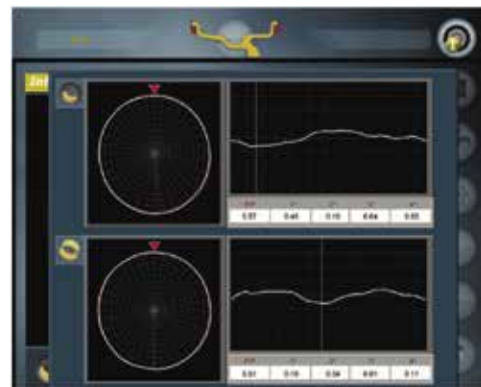

Item No.	Description	Power requirements	Balancing speed	Average cycle time	Rim width capacity	Rim diameter capacity	Max. tire diameter	Max. wheel weight	Shaft diameter	Shipping weight
ER100	Fully automatic laser wheel balancer and diagnostic center	110VAC, 50/60 Hz, 1 ph	100 rpm	6 sec.	1.5"-20" (40-510 mm)	10"-30" (265-765 mm)	40" (1,016 mm)	165 lbs (75 Kg)	40 mm	650 lbs (295 kg)

# TECH Wheel Balancers

## Video Diagnostic Wheel Balancer For Cars & Light Trucks

- Industrial video touch screen professional wheel balancer especially designed for tire dealers.
- Pneumatic locking.
- Automatic distance and diameter entry with width sonar 3D.
- Full-time accuracy with Static unbalance always displayed on screen.
- Runout sonar for wheel diagnostic.
- Electromagnetic brake holds the wheel in position.



Item No.	Description	Power requirements	Balancing speed	Average cycle time	Rim width capacity	Rim diameter capacity	Max. tire diameter	Max. wheel weight	Shaft diameter	Shipping weight
ER75TD	Video diagnostic wheel balancer for cars and light trucks	110VAC or 220VAC, 50/60 Hz, 1 ph	100 rpm	5 sec.	1.5"-20" (40-510 mm)	10"-30" (265-765 mm)	42" (1,067 mm)	165 lbs (75 Kg)	40 mm	400 lbs (180 Kg)

## Video Diagnostic Wheel Balancer For Cars & Light Trucks

- Industrial video touch screen professional wheel balancer especially designed for tire dealers.
- Standard locking with quick-nut.
- Automatic distance and diameter entry with width sonar 3D.
- LED to light the work space inside the rim.
- Full-time accuracy with Static unbalance always displayed on screen.
- Electromagnetic brake holds the wheel in position.



Item No.	Description	Power requirements	Balancing speed	Average cycle time	Rim width capacity	Rim diameter capacity	Max. tire diameter	Max. wheel weight	Shaft diameter	Shipping weight
ER73TD	Video diagnostic wheel balancer for cars and light trucks	110VAC or 220VAC, 50/60 Hz, 1 ph	100 rpm	5 sec.	1.5"-20" (40-510 mm)	10"-30" (265-765 mm)	42" (1,067 mm)	165 lbs (75 Kg)	40 mm	390 lbs (177 Kg)

## Professional Wheel Balancer For Cars & Light Trucks

- Professional digital wheel balancer especially designed for tire dealers.
- Standard locking with quick-nut.
- Automatic distance and diameter entry with width sonar 3D.
- LED to light the work space inside the rim.
- Full-time accuracy with Static unbalance always displayed on screen.
- Electromagnetic brake holds the wheel in position.



Item No.	Description	Power requirements	Balancing speed	Average cycle time	Rim width capacity	Rim diameter capacity	Max. tire diameter	Max. wheel weight	Shaft diameter	Shipping weight
ER72TD	Professional wheel balancer for cars and light trucks	110VAC or 220VAC, 50/60 Hz, 1 ph	100 rpm	5 sec.	1.5"-20" (40-510 mm)	10"-30" (265-765 mm)	42" (1,067 mm)	165 lbs (75 Kg)	40 mm	370 lbs (168 Kg)



# TECH Wheel Balancers

## Digital Wheel Balancer For Cars & Light Trucks

- Automatic distance and diameter entry 2D.
- Optional width sonar 3D.
- Standard locking with quick-nut.
- Wide working space.
- Laser Line for quicker stick-on weight placement.
- LED to light the work space inside the rim.
- Electromagnetic brake holds the wheel in position.



Item No.	Description	Power requirements	Balancing speed	Average cycle time	Rim width capacity	Rim diameter capacity	Max. tire diameter	Max. wheel weight	Shaft diameter	Shipping weight
ER71	Digital wheel balancer for cars and light trucks	110VAC, 50/60 Hz, 1 ph	100 rpm	5 sec.	1.5"-20" (40-510 mm)	10"-30" (265-765 mm)	40" (1,016 mm)	165 lbs (75 Kg)	40 mm	354 lbs (160 Kg)

## Motorized Digital Automatic Wheel Balancer

- Space saving motorized wheel balancer.
- For cars and light trucks, motorcycle and scooter wheels (by means of optional accessories).
- Automatic distance and diameter entry 2D.
- Direct weight location program (no repositioning of stick-on weight).
- Multi-function display.
- SPLIT program to hide the counterweight behind the spokes.
- Foot pedal brake for easy weight placement.



Item No.	Description	Power requirements	Balancing speed	Average cycle time	Rim width capacity	Rim diameter capacity	Max. tire diameter	Max. wheel weight	Shaft diameter	Shipping weight
EZ9	Motorized digital automatic wheel balancer	110VAC, 50/60 Hz, 1 ph	100 rpm	5 sec.	1.5"-20" (40-510 mm)	10"-30" (265-765 mm)	36" (914 mm)	165 lbs (75 Kg)	40 mm	260 lbs (118 kg)

## Portable Hand Spin Wheel Balancer For Cars & Light Trucks

- Space saving wheel balancer with excellent technical specifications.
- Automatic distance and diameter entry 2D.
- Dual voltage power supply 12VDC - 110VAC.
- Standard lightweight battery pack for use when power not available.
- Direct selection ounce or grams.
- Direct weight location program (no repositioning of stick-on weight).
- Foot pedal brake for easy weight placement.



Item No.	Description	Power requirements	Balancing speed	Average cycle time	Rim width capacity	Rim diameter capacity	Max. tire diameter	Max. wheel weight	Shaft diameter	Shipping weight
EZ29	Portable hand spin wheel balancer for cars and light trucks	12VDC - 110VAC, 50/60 Hz	100 rpm	5 sec.	1.5"-20" (40-510 mm)	10"-30" (265-765 mm)	42" (1,067 mm)	165 lbs (75 Kg)	40 mm	150 lbs (68 kg)

# TECH Wheel Balancers

## Compact Hand Spin Wheel Balancer For Cars & Light Trucks

- Space saving wheel balancer with excellent technical specifications.
- Manual data entry.
- Multifunctional digital panel with Behind Spoke (Split) mode.
- Dual voltage power supply 12VDC - 110VAC.
- Standard lightweight battery pack for use when power not available.
- Comes with a tire changer mounting clamp to attach EZ1 to a swing-arm machine with tank up to 7" outside diameter.



Item No.	Description	Power requirements	Balancing speed	Average cycle time	Rim width capacity	Rim diameter capacity	Max. tire diameter	Max. wheel weight	Shaft diameter	Shipping weight
EZ1	Compact hand spin wheel balancer for cars and light trucks	12VDC - 110VAC, 50/60 Hz	100 rpm	5 sec.	1.5"-20" (40-510 mm)	10"-30" (265-765 mm)	-	100 lbs (45 Kg)	40 mm	150 lbs (68 kg)

## Digital Wheel Balancer For Motorcycle Wheels

- For traditional bearing type motorcycle wheels.
- For rear flanged wheels (single arm) and scooter wheels with optional AGF kit.
- Automatic distance and diameter entry 2D.
- Easy spinning and braking by motorized roller.
- Fixed shaft: the wheel runs freely on its own bearings thus reproducing the exact mounting of the wheel on the motorbike for diagnosing bearing problems.



Item No.	Description	Power requirements	Balancing speed	Average cycle time	Rim width capacity	Rim diameter capacity	Max. tire diameter	Max. wheel weight	Shaft diameter	Shipping weight
K22	Digital wheel balancer for motorcycle wheels	110VAC, 50/60 Hz, 1 ph	80 rpm	5 sec.	1.5"-20" (40-510 mm)	10"-24" (265-610 mm)	28" (711 mm)	66 lbs (30 Kg)	15 mm	220 lbs (100 Kg)

## The Only Professional Truck Wheel Balancer In The World With Pneumatic Locking

- Pneumatic locking.
- Automatic distance and diameter entry 2D.
- Powerful three-phase motor.
- Integrated pneumatic lift for wheels up to 550 lbs (250 Kg).
- Electro-pneumatic stationary brake.
- 15" TFT screen.
- Full-time accuracy with Static unbalance always displayed.



Item No.	Description	Power requirements	Balancing speed	Average cycle time	Rim width capacity	Rim diameter capacity	Max. tire diameter	Max. wheel weight	Shaft diameter	Shipping weight
C202SE	Professional truck wheel balancer with pneumatic locking	230/400VAC, 50/60 Hz, 3 ph	70 rpm	< 20 sec.	1.5"-20" (40-510 mm)	10"-30" (265-765 mm)	51" (1,295 mm)	550 lbs (250 Kg)	60 mm	800 lbs (363 Kg)

## TECH Wheel Balancers

### Professional Truck Wheel Balancer For Cars, Heavy-Duty Trucks & Buses

- Automatic distance and diameter entry 2D.
- SPLIT program and Optimization program.
- Integrated pneumatic lift for wheels up to 550 lbs (250 Kg).
- Electro-pneumatic stationary brake.
- Full-time accuracy with Static unbalance always displayed.
- 15" TFT screen.
- ALU-S function for light alloy or special shaped rims (car and truck).



Item No.	Description	Power requirements	Balancing speed	Average cycle time	Rim width capacity	Rim diameter capacity	Max. tire diameter	Max. wheel weight	Shaft diameter	Shipping weight
C218	Professional truck wheel balancer	110VAC, 50/60 Hz, 1 ph	70 rpm (truck) - 100 rpm (car)	10-20 sec.	1.5"-20" (40-510 mm)	10"-30" (265-765 mm)	51" (1,295 mm)	550 lbs (250 Kg)	40 mm	750 lbs (340 Kg)

### Professional Truck Wheel Balancer For Cars, Heavy-Duty Trucks & Buses

- Automatic distance and diameter entry 2D.
- SPLIT program and Optimization program.
- Integrated pneumatic lift for wheels up to 550 lbs (250 Kg).
- Electro-pneumatic stationary brake.
- Full-time accuracy with Static unbalance always displayed.
- ALU-S function for light alloy or special shaped rims (car and truck).
- 51" wheel guard.



Item No.	Description	Power requirements	Balancing speed	Average cycle time	Rim width capacity	Rim diameter capacity	Max. tire diameter	Max. wheel weight	Shaft diameter	Shipping weight
C212	Professional truck wheel balancer	110VAC, 50/60 Hz, 1 ph	70 rpm (truck) - 100 rpm (car)	10-20 sec.	1.5"-20" (40-510 mm)	10"-30" (265-765 mm)	51" (1,295 mm)	550 lbs (250 Kg)	40 mm	615 lbs (280 Kg)

### Portable Hand Spin Truck Wheel Balancer For Cars, Heavy-Duty Trucks & Buses

- Portable wheel balancer with automatic distance and diameter entry 2D.
- Dual voltage power supply 12VDC - 110VAC.
- Easy hand spin system requires minimum effort for spinning.
- Manual lifting system can easily handle wheel up to 550 lbs (250 Kg).
- SPLIT program and Optimization program.
- Wheels for easy portability.
- Battery pack for use when power not available.



Item No.	Description	Power requirements	Balancing speed	Average cycle time	Rim width capacity	Rim diameter capacity	Max. tire diameter	Max. wheel weight	Shaft diameter	Shipping weight
C206	Portable hand spin truck wheel balancer	12VDC - 110VAC, 50/60 Hz	70 rpm (truck) - 100 rpm (car)	10-20 sec.	1.5"-20" (40-510 mm)	10"-30" (265-765 mm)	51" (1,295 mm)	550 lbs (250 Kg)	40 mm	371 lbs (170 Kg)

## TECH Tire Changers

### Professional, Super-Automatic Leverless Center Post Tire Changer

- For standard, low profile and run-flat wheels of cars and light commercial vehicles.
- Quick locking expanding nut with centering by cone and quick lock-ring.
- Fully adjustable bead breaker with Smart Blade System.
- Double Effect bead breaker.
- Bead breaker shovel with Power-Out System.
- Multi-function roller bead loosening unit.



Item No.	Description	Power requirements	Rim clamping range	Max. tire outside	Max. tire width	Bead breaker force (Smart Blade)	Bead breaker force (Roller unit)	Operating pressure	Shipping weight
SM1120	Professional, super-automatic tire changer	220VAC, 1 ph / 2 speed	12"-30"	1,200 mm (47")	410 mm (16")	7,056 lbs (3,200 Kg)	2,630 lbs (1,200 Kg)	10 bar (145 psi)	1,000 lbs (453 kg)

### Professional Tire Changer With Smart Blade For Cars & Light Truck Wheels

- Automatic tire changer with a tilting back post pneumatically controlled by a pedal, for conventional low profile and Run-Flat wheels of cars and light commercial vehicles.
- Dual clamping cylinders.
- Adjustable table with inflators on each clamp.
- Double Effect bead breaker.
- Bead breaker shovel with Power-Out System.



Item No.	Description	Power requirements	Inside clamping range	Outside clamping range	Max. tire outside	Max. tire width	Bead breaker force	Operating pressure	Shipping weight
SM951HPA	Professional tire changer with Smart Blade	110VAC, 50/60 Hz, 1 ph	13"-28"	10"-26"	1,100 mm (43")	415 mm (16")	7,000 lbs (3,175 Kg)	10 bar (145 psi)	1,000 lbs (453 kg)

### Professional Tire Changer With Smart Blade For Cars & Light Truck Wheels

- Automatic tire changer with a tilting back post pneumatically controlled by a pedal, for conventional low profile and Run-Flat wheels of cars and light commercial vehicles.
- Dual clamping cylinders.
- Adjustable table with inflators on each clamp.
- Double Effect bead breaker.
- Bead breaker shovel with Power-Out System.



Item No.	Description	Power requirements	Inside clamping range	Outside clamping range	Max. tire outside	Max. tire width	Bead breaker force	Operating pressure	Shipping weight
SM951	Professional tire changer with Smart Blade	110VAC, 50/60 Hz, 1 ph	13"-28"	10"-26"	1,100 mm (43")	415 mm (16")	7,000 lbs (3,175 Kg)	10 bar (145 psi)	800 lbs (360 kg)



# TECH Tire Changers

## Swing Arm Tire Changer With Table Top Inflators

- Suitable for car and light commercial wheels.
- Clamping range 10"-28".
- Air tank in tower.
- Dual clamping cylinders.
- Semi-automatic swing arm.
- Inserts protect aluminum wheels.
- Adjustable table with inflators on each clamp.
- Adjustable bead breaker.



Item No.	Description	Power requirements	Inside clamping range	Outside clamping range	Max. tire outside	Max. tire width	Bead breaker force	Operating pressure	Shipping weight
SM915ATI	Swing arm tire changer with table top inflators	110VAC, 50/60 Hz, 1 ph	13"-28"	10"-26"	1,200 mm (47")	380 mm (15")	5,550 lbs (2,517 Kg)	10 bar (145 psi)	630 lbs (285 kg)

## Semi-Automatic Tire Changer With Swing Arm

- Suitable for car and light commercial vehicle.
- Clamping range 13"-26".
- Air tank in tower.
- Dual clamping cylinders.
- Semi-automatic swing arm.
- Inserts protect aluminum wheels.
- Inflators on each clamp.
- Optional Press Arm and bead pressing tool for low profile tires.



Item No.	Description	Power requirements	Inside clamping range	Outside clamping range	Max. tire outside	Max. tire width	Bead breaker force	Operating pressure	Shipping weight
SM825	Semi-automatic tire changer with swing arm	110VAC, 50/60 Hz, 1 ph	15"-26"	13"-24"	1,200 mm (47")	380 mm (15")	5,550 lbs (2,517 Kg)	10 bar (145 psi)	630 lbs (285 kg)

## Swing Arm Tire Changer For Motorcycles & ATVs

- Dual clamping cylinders.
- Clamping range 6"-24".
- Semi-automatic swing arm.
- Inserts protect aluminum wheels.
- Bead breaker designed for motorcycles and ATVs.
- Optional Press Arm.
- Comes fully assembled.



Item No.	Description	Power requirements	Inside clamping range	Outside clamping range	Max. tire outside	Max. tire width	Bead breaker force	Operating pressure	Shipping weight
SM900+	Swing arm tire changer for motorcycles and ATVs	110VAC, 50/60 Hz, 1 ph	-	6"-24"	1,010 mm (39")	240 mm (9.5")	5,550 lbs (2,517 Kg)	10 bar (145 psi)	485 lbs (220 kg)

# TECH Tire Changers

## Universal Tire Changer For Trucks & Bus Wheels

- Clamping range 14" - 46" (up to 56" with optional extensions).
- Mobile control unit.
- Two speed motor.
- Bi-directional rotation.
- Self-centering universal wheel chuck.
- Comes fully assembled.



Item No.	Description	Power requirements	Rim clamping range	Max. tire outside	Max. tire width	Max. tire weight	Bead breaker force	Operating pressure	Shipping weight
SM56T	Universal tire changer for trucks and bus wheels	220VAC, 50/60 Hz, 3 ph	14"-46" (56" with optional extensions)	2,300 mm (90.5")	1,070 mm (42")	3,300 lbs (1,500 Kg)	6,000 lbs (2,721 Kg)	130 bar (1,885 psi)	2,000 lbs (907 kg)

## Universal Tire Changer For Trucks & Bus Wheels

- Clamping range 13"-27".
- Mobile control unit.
- Bi-directional rotation.
- Self-centering universal wheel chuck.
- Comes fully assembled.



Item No.	Description	Power requirements	Rim clamping range	Max. tire outside	Max. tire width	Max. tire weight	Bead breaker force	Operating pressure	Shipping weight
CM27T	Universal tire changer for trucks and bus wheels	220VAC, 50/60 Hz, 1 ph	13"-27"	1,600 mm (63")	780 mm (30")	3,300 lbs (1,500 Kg)	4,100 lbs (1,860 Kg)	130 bar (1,885 psi)	1,415 lbs (640 kg)

# TECH Wheel Alignment Systems

## 3D Wheel Alignment System For Cars & Light Trucks

- High definition targets.
- Measurement of all required alignment specifications.
- Targets with no electronics and batteries.
- Optional VIN barcode scanner.
- PC computer and storage cabinet.
- Windows® operating system.
- Brake pedal depressor and steering lock.
- 24" TFT monitor, printer, keyboard, mouse.
- Four 4-point clamps 12"-24"\* with universal L=45mm reversible grips and targets.
- Complete car database with possible customization.
- Alignment specification history of 40+ years.



Item No.	Description	Technical Data
DWA4000	3D wheel alignment system for cars and light trucks	Computer - 24" monitor - printer Software and database for cars Four 4-point clamps 12"-24"* with universal pins and targets Steering wheel lock and brake pedal depressor

\*Does not mean rim diameter

## 8 Camera CCD Alignment System For Cars & Light Trucks

- Four wireless BT<sup>2</sup> rechargeable alignment heads equipped with lithium ion batteries for long life, clamps and charging station standard.
- Optional VIN barcode scanner.
- Laptop computer and storage cabinet standard.
- Accelerometers (newest measuring technology).
- Windows® based software with multiple languages.
- Brake pedal depressor and steering lock.
- 24" TFT monitor and printer.
- 24" wheel clamping range\* (30" optional).
- Power supply and USB BT<sup>2</sup> antenna.



Item No.	Description	Technical Data
DWA1000XL	8 camera CCD alignment system for cars and light trucks	Laptop computer - 24" monitor - printer Software and database with car and light trucks 4 car measuring heads 4 clamps + safety elastic band + 1 set of pins Steering wheel lock and brake pedal depressor

\*Does not mean rim diameter

# TECH Wheel Alignment Systems

## 8 Camera CCD Basic Alignment System For Cars & Light Trucks

- Four wireless BT<sup>2</sup> rechargeable alignment heads equipped with lithium ion batteries for long life, clamps and charging station standard.
- Optional VIN barcode scanner.
- Laptop computer and storage cabinet.
- Accelerometers (newest measuring technology).
- Windows® based software with multiple languages.
- 24" wheel clamping range\* (30" optional).
- Power supply and USB BT<sup>2</sup> antenna.
- Complete car database with possible customization.



Item No.	Description	Technical Data
DWA1000XLB	8 camera CCD basic alignment system for cars and light trucks	Laptop computer Software and database with car and light trucks 4 car measuring heads 4 clamps + safety elastic band + 1 set of pins

\*Does not mean rim diameter

## 8 Camera CCD Alignment System For Heavy-Duty Trucks & Buses

- Four wireless BT<sup>2</sup> rechargeable alignment truck heads equipped with lithium ion batteries for long life, clamps and charging station standard.
- PC computer and storage cabinet.
- Accelerometers (newest measuring technology).
- Windows® based software with multiple languages.
- Brake pedal depressor and steering lock.
- 24" TFT monitor and printer.
- 30" wheel clamping range\*.
- Handles large trucks with standard accessories.
- Power supply and USB BT<sup>2</sup> antenna.



Item No.	Description	Technical Data
DWA1000XLT	8 camera CCD alignment system for heavy-duty trucks and buses	Computer - 24" monitor - printer Software and database with heavy-duty trucks 4 truck measuring heads 4 clamps with 30" extensions 3 sets of pins (standard, truck and dually) Wheel grabber kit with 50" arm kit Steering wheel lock and brake pedal depressor

\*Does not mean rim diameter

Full line of accessories available. Contact your TECH distributor!



## TECH Tire Changer Mount/Demount Heads

### TMRTC0343-6+ Nylon Mount And Demount Head (6 Pack)

O.E.M.	Part Number	Tire Changer
Accuturn	SM102529	220A, All Other Models Require 102765 Adapter
Hunter	RP6 0343B	RP6 0343B TC250 • TC300 • TC325 • TC350 TC2000 • TC3250 • TC3500 TC3000 And TC 3100 Series (Require Adapter)
Ranger		Most Models Except R980A, R980E (Some Require Adapters)

+Denotes special order item.



### TMRTC343+ Red Nylon Mount And Demount Head (Each) TMRTC343-6+ Red Nylon Mount And Demount Head (6 Pack)

O.E.M.	Part Number	Tire Changer
Hunter	221-675-2	TC 250 • TC 300 • TC325
Hunter	221-675-2-B	TC250 • TC300 • TC325 • TC350 TC2000 • TC3250 • TC3500 TC3000 And TC 3100 Series (Require Adapter)

+Denotes special order item.

### TMRTC183061+ Nylon Mount / Demount Head Kit With Tapered Hole

Use With Tapered Shaft 182767 or 182812

O.E.M.	Part Number	Tire Changer
Coats	8183061	5030 • 5040 • 5050 • 5060 • 5065 6050 • 6060 • 6065 • 7050 • 7055 7060 • 7065 • 7655 • 7660 • 7665

+Denotes special order item.



### TMRTC182960+

O.E.M.	Part Number	Tire Changer
Coat	8182960	
Ranger	5150524	For R980A And R980E (Requires 5150523 Mounting Flange)

+Denotes special order item.



### TMRTC184432+ Low Profile Grey Nylon Mount / Demount Head Kit

For Use With Low Profile Tires

O.E.M.	Part Number	Tire Changer
Coats	8184432	5030 • 5040 • 5050 • 5060 • 5065 6050 • 6060 • 6065 • 7050 • 7055 7060 • 7065 • 7655 • 7660 • 7665

+Denotes special order item.

## TECH Tire Changer Mount/Demount Heads

### TMRTC250309+ Nylon Mount / Demount Head Kit With Round Hole

Not For Use On Hofmann 1550, 1620 and 1625

O.E.M.	Part Number	Tire Changer
All Tool	G2008401	All Models
Coats	82008402	RC 1 • 5 • 10 • 15 • 20 • Early 5060 9010 • 9024 • APX90
Corgi	250309	All Rim Clamp (Optional Accessory)
Hofmann	2200981	All Earlier Models Except 1550 • 1620 • 1625
Sice	2200981	M39, S40, S41, S42, S43, S45, S408MAXI, S435, S436, S436TC

+Denotes special order item.



### TMRTC450310+ Nylon Mount / Demount Head With Round Hole (Head Only)

For TC 250309 Mount / Demount Head Kit

O.E.M.	Part Number	Tire Changer
All Tool	G3008403	All Models
Coats	83008403	RC 1 • 5 • 10 • 15 • 20 • Early 5060 9010 • 9024 • APX90
Corgi	450310	All Rim Clamp (Optional Accessory)
Giuliano	3008403	Shaft needs to be turned 180° for this Head to work
Hofmann	8314813	All Earlier Models Except 1550 • 1620 • 1625
Hunter	RP11-8314813	Fits All TCX Series (Earlier TCX500 Requires Upgrade Shaft And Adapter Kit RP11-8-114-00091)
Sice	8314813	M39, S40, S41, S42, S43, S45, S408MAXI, S435, S436, S436TOP

+Denotes special order item.

### TMRTC14024784+ Nylon Mount/Demount Head Kit

O.E.M.	Part Number	Tire Changer
Accuturn	14024784	3602 • 3602HP • 4260 • 4560MR • 4602 • 5602 • 5602 HP
Hofmann	4024784	1520 • 1565 • 1620 • 1625 • 1625EM • 3300 • 3300EM Monty 1270, 2300, 3000, 3000GP
John Bean	EAA 0247G20A	EHP System IVE • IV • III • IIE
Snap On	EAA 0247G20A	All Models

+Denotes special order item.



### TMRTC20024335+ Nylon Mount/Demount Head For TMRTC14024784 Mount / Demount Head Kit (Head Only)

O.E.M.	Part Number	Tire Changer
Accuturn	20024335	3602 • 3602HP • 4260 • 4560MR • 4602 • 5602 • 5602 HP
Hofmann	24335	1520 • 1565 • 1620 • 1625 • 1625EM • 3300 • 3300EM Monty 1270, 2300, 3000, 3000GP
John Bean	24335	EHP System IVE • IV • III • IIE
Snap On	24335	All Models

+Denotes special order item.

## TECH Tire Changer Stainless Steel Mount/Demount Heads & Inserts

### TMRTC182788+ Stainless Steel Mount & Demount Head With Tapered Hole

O.E.M.	Part Number	Tire Changer
Coats	<b>8182788</b>	5030 • 5040 • 5050 • 5060 • 5065 • 5070 6050 • 6060 • 6065 • 7050 • 7055 7060 • 7065 • 7655 • 7660 • 7665

+Denotes special order item.

### TMRTI182961+ (2 PK) – TI182963 (12 PK) Plastic Insert

#### For TC182788 & TC183429 Stainless Steel Mount/Demount Heads

O.E.M.	Part Number	Tire Changer
Coats	<b>8182961 (2Pk)</b>	RC 1 • 5 • 10 • 15 • 20 • Early 5060
	<b>8182963 (12Pk)</b>	5030 • 5040 • 5050 • 5060 • 5065 • 5070 6050 • 6060 • 6065 • 7050 • 7055 7060 • 7065 • 7655 • 7660 • 7665

+Denotes special order item.

### TMRTC101608+ Plastic Insert For Sicam Tire Changer (5 PK)

O.E.M.	Part Number	Tire Changer
Sicam	<b>SM101608</b>	Accuturn, Bosch, Sicam

+Denotes special order item.

### TMRTI254341A+ Plastic Inserts For Mount & Demount Head (10 PK)

#### Includes Allen Wrench

O.E.M.	Part Number	Tire Changer
Coats	<b>89209611</b>	RC 1 • 5 • 10 • 20 • 9010 • 9024
Corgi	<b>254341A</b>	2024 • 9220 • 9824

+Denotes special order item.

### TMRTI20011064+ Plastic Inserts For Mount & Demount Head

#### Bulk – Does Not Include Pin

O.E.M.	Part Number	Tire Changer
Accuturn	<b>20011064</b>	3402 • 3450 • 3602 • 4602
Accuturn	<b>24016079</b>	5802HP • 5850HP • 5602

+Denotes special order item.

### TMRTI4096-10+ Hunter Nose Inserts From TI11400096 Kit For Steel Mount Heads (10 PK)

O.E.M.	Part Number	Tire Changer
Hunter		TCX Series

+Denotes special order item.



## TECH Tire Changer Stainless Steel Mount/Demount Heads & Inserts

### TMRTI4636-10+ Hunter Back Inserts From TI11400096 Kit For Steel Mount Heads (10 Pk)

O.E.M.	Part Number	Tire Changer
Hunter		TCX Series

+Denotes special order item.

### TMRTI11400096+ Insert Kit For Hunter Steel Mount Heads

#### 10 Pcs. Each Of TI4096 & TI4636

O.E.M.	Part Number	Tire Changer
Hunter	<b>RP11-8-11400096</b>	TCX Series

+Denotes special order item.

### TMRTC247G15A-10+ Plastic Long Inserts For Stainless Mount & Demount Head (10 PK)

O.E.M.	Part Number	Tire Changer
Hofmann	<b>ST4024181</b>	All Models
Snap-On	<b>EAA0247G15A</b>	All Models

+Denotes special order item.



## TECH Jaws & Clamping Kits

### TMRTC113125C 3+ Position Extended X-Clamp Kit

#### For Coats X-Models With Adjustable Carriers External (outside/in) Wheel Clamping 6" - 22" Wheels

**Kit Includes:** TC 182250 Position Push Buttons (4 Pc)  
TC 184126 3 Position X-Clamp (4 Pc)

O.E.M.	Part Number	Tire Changer
Coats	<b>8113125C</b>	50X • 60X • 70X (ONLY Works With Upgraded Carriage System. Does Not Work With 5030, 5040, 5045. Must Use TC182247.)

+Denotes special order item.



### TMRTC183604+ Quilted Clamp Sock (10 PK)

#### For Jaws And Coats Rim Clamp Tire Changers

O.E.M.	Part Number	Tire Changer
Coats	<b>8183604</b>	All Tire Changers (Except 9010 and 9024E)

+Denotes special order item.



# TECH Tire Changer Products

## Bead Lift & Combo Tools

Item No.	Description
<b>TMRCT768+</b>	COMBO TOOL, specifically designed to mount and demount tires. Use with TI 30 Demount & TI 55 Mount Booties.
<b>TMRTI30+</b>	LARGE WHITE DEMOUNT BOOTIE PROTECTOR for demount end of CT768/TC66679 Combo Tool
<b>TMRTC181354+</b>	20 BEAD LIFTING TOOL for all rim clamp tire changers
<b>TMRTI55+*</b>	SMALL WHITE MOUNT BOOTIE PROTECTOR for mount end of CT768/TC66679 Combo Tool
<b>TMRTC2505+</b>	BEAD LIFT "WAVE" TOOL BAR, specially shaped for difficult tire beads

+Denotes special order item.  
\*Item not shown.



## Tire Spreaders & Accessories

Item No.	Description
<b>TMRWL98063+</b>	WORK LAMP FOR TIRE SPREADERS

+Denotes special order item.

## Air Gauges & Lens Cover

Item No.	Description
<b>TMRAG107518+</b>	AIR GAUGE for Coats old style tire changers, bolts on back with clips
<b>TMRAG107985+</b>	AIR GAUGE for Coats tire changers, flange mount

+Denotes special order item.



## Inflator Hose Assemblies

Item No.	Description
<b>TMRHA67715+</b>	INFLATOR HOSE ASSEMBLY with open end barbed style euro chuck, 52" long. All brass connectors (1/4" I.D. - 19 BSP) hose includes euro chuck.
<b>TMRHA106871+</b>	INFLATOR HOSE ASSEMBLY with open end barbed style euro chuck, 60" long. All brass connectors (1/4" I.D. - 19 BSP) hose includes euro chuck.

+Denotes special order item.



## Tire Lube Supplies

Item No.	Description
<b>TMLB106259+</b>	LUBE BUCKET FOR TIRE CHANGERS (straight)
<b>TMLB106572+</b>	LUBE BUCKET FOR TIRE CHANGERS (angled)
<b>TMLB66006+</b>	LUBE BUCKET FOR TIRE CHANGERS (straight)

+Denotes special order item.  
TECH Tire & Wheel Solutions | Vol. 80



# TECH Brake Lathe Products

## Carbide Bits



Item No.	Description
<b>TMRCB69+</b>	ROUND POSITIVE RAKE CARBIDE BIT
<b>TMRCB6914-10+</b>	NEGATIVE RAKE CARBIDE BIT .030 RADIUS (10 PK)
<b>TMRCB90488+</b>	POSITIVE RAKE CARBIDE BIT .20 RADIUS 15° ANGLE (10 PK)
<b>TMRCB433796+</b>	POSITIVE RAKE CARBIDE BIT 11° ANGLE • 1/64" RADIUS (10 PK)

+Denotes special order item.

## Silencers



Item No.	Description
<b>TMRBS10+</b>	ADJUSTABLE VENTILATED ROTOR SILENCER BAND
<b>TMRBS17-2+</b>	SMALL BLACK SOLID ROTOR SILENCER BAND 6-9" Diameter (2 Pack)
<b>TMRBS22-2+</b>	LARGE BLACK SOLID ROTOR SILENCER BAND 10-12" Diameter (2 Pack)
<b>TMRCS1+</b>	CLIP ON SILENCER

+Denotes special order item.

# TECH Lift Pads

Item No.	Description
TMRLP600+	MOLDED RUBBER PAD for Ammco, Ben Pearson, Challenger & Weaver. 3 <sup>3</sup> / <sub>4</sub> " x 5 <sup>3</sup> / <sub>4</sub> " x 3 <sup>3</sup> / <sub>4</sub> ". 3 <sup>1</sup> / <sub>4</sub> " between bolt holes. 4 piece kit.
TMRLP601+	MOLDED RUBBER PAD for Benwil & Bishamon. 4 <sup>1</sup> / <sub>2</sub> " x 3 <sup>5</sup> / <sub>8</sub> " x 3 <sup>3</sup> / <sub>4</sub> ". 1 <sup>7</sup> / <sub>8</sub> " (W) between bolt holes. 1 <sup>5</sup> / <sub>8</sub> " (L) between bolt holes. 4 piece kit.
TMRLP602+	HEAVY DIE CUT MATERIAL for Challenger. VBM Round. 5 <sup>7</sup> / <sub>8</sub> " x 5 <sup>7</sup> / <sub>8</sub> " x 1 <sup>1</sup> / <sub>4</sub> ". 3" between bolt holes. 4 piece kit.
TMRLP603+	ROUGH HEAVY DIE CUT MATERIAL (8 Sided) for Forward, Eagle, Gemini, Worth & American. Pad only 5" x 5" x 1 <sup>1</sup> / <sub>4</sub> ". 3 <sup>3</sup> / <sub>4</sub> " between bolt holes. 4 piece kit.
TMRLP605+	MOLDED RUBBER PAD For Nussbaum, Phoenix & Force (old). 5" x 1". 3 <sup>1</sup> / <sub>2</sub> " between bolt holes. 4 piece kit.
TMRLP606+	HEAVY DIE CUT for flip up height extensions. Pad only 5 <sup>1</sup> / <sub>2</sub> " x 3" x 1 <sup>1</sup> / <sub>4</sub> ". 3 <sup>1</sup> / <sub>8</sub> " between bolt holes. 4 piece kit.
TMRLP607+	MOLDED RUBBER PAD for Western & American. Slip on, 4 <sup>1</sup> / <sub>2</sub> " x 4" x 1". 4 piece kit.
TMRLP608+	BEND PAK SQUARE, SLIP ON, MOLDED RUBBER PAD 5 <sup>1</sup> / <sub>2</sub> " x 5 <sup>1</sup> / <sub>2</sub> " x 1". 4 piece kit.
TMRLP609+	HEAVY DUTY CUT MATERIAL FOR ROTARY SPO 12 4" x 3 <sup>1</sup> / <sub>4</sub> " x 1 <sup>1</sup> / <sub>4</sub> ". 3" (W) between bolt holes. 2 <sup>3</sup> / <sub>8</sub> " (L) between bolt holes. 4 piece kit.
TMRLP610+	MOLDED RUBBER PAD, SQUARE, for Wheeltronics, Snap-On & Ammco. 5 <sup>1</sup> / <sub>4</sub> " x 4 <sup>1</sup> / <sub>2</sub> " x 1". 4 piece kit.
TMRLP612+	LIFT PADS, HEAVY DIE CUT MATERIAL, for Globe. 4 <sup>1</sup> / <sub>2</sub> " x 3 <sup>3</sup> / <sub>8</sub> ". 4 piece kit.
TMRLP613+	SOLID MOLDED RUBBER BLOCK PAD, 6" x 4 <sup>3</sup> / <sub>4</sub> " x 3". 4 piece kit.
TMRLP615+	SOLID MOLDED RUBBER BLOCK PAD, 6 <sup>1</sup> / <sub>4</sub> " x 4 <sup>3</sup> / <sub>4</sub> " x 1 <sup>1</sup> / <sub>2</sub> ". 4 piece kit.
TMRLP616+	ALM LIFT PADS MOLDED RUBBER PAD (Like OEM) 6 <sup>1</sup> / <sub>4</sub> " x 1 <sup>1</sup> / <sub>8</sub> ". 4 piece kit.
TMRLP617+	RUBBER PAD FOR CHALLENGER CL9 & CL10 (Like OEM) 4" x 4" x 7 <sup>1</sup> / <sub>16</sub> ". 4 piece kit.
TMRLP618+	BEND PAK SQUARE BOLT-ON MOLDED RUBBER PAD 5 <sup>1</sup> / <sub>2</sub> " x 5 <sup>1</sup> / <sub>2</sub> " x 1". 3 <sup>5</sup> / <sub>8</sub> " (W) between bolt holes. 3 <sup>5</sup> / <sub>8</sub> " (L) between bolt holes. 4 piece kit.
TMRLP619+	MOLDED RUBBER PAD for Wheeltronics, Snap-On & Ammco round bolt on. 4.812" x 1.125". 4 piece kit.
TMRLP620+	ROUND RUBBER PAD for Challenger. 5 <sup>1</sup> / <sub>2</sub> " x 3 <sup>3</sup> / <sub>4</sub> ". 4 piece kit.
TMRLP621+	MOLDED RUBBER PAD for Globe. 3" x 4 <sup>1</sup> / <sub>2</sub> " x 1". 2 <sup>3</sup> / <sub>8</sub> " (W) between bolt holes. 1 <sup>5</sup> / <sub>8</sub> " (L) between bolt holes. 4 piece kit.
TMRLP622+	MOLDED RUBBER PAD for Quality. 4 <sup>3</sup> / <sub>4</sub> " round. 4 piece kit.
TMRLP623+	VBM ROUND HEAVY MOLDED MATERIAL for Challenger. 3 <sup>3</sup> / <sub>8</sub> " Round. 3" between bolt holes. 4 piece kit.



+Denotes special order item.

# TECH Automotive Tire Service Products

## Bulge Style Acorn Lug Nuts

Item No.	Description	Thread Size	Hex	Height
TMRTI146+*	BULGE STYLE ACORN CHROME LUG NUT	1/2"	3/4"	1.38"
TMRTI147+	BULGE STYLE ACORN CHROME LUG NUT	12mm - 1.25	3/4"	1.38"
TMRTI148+*	BULGE STYLE ACORN CHROME LUG NUT	12mm - 1.50	3/4"	1.38"
TMRTI149+*	BULGE STYLE ACORN CHROME LUG NUT	14mm - 1.50	3/4"	1.38"
TMRTI151+*	LONG BULGE STYLE ACORN CHROME LUG NUT	1/2"	13/16"	1.75"
TMRTI152+*	LONG BULGE STYLE ACORN CHROME LUG NUT	12mm - 1.50	13/16"	1.75"
TMRTI154+*	LONG BULGE STYLE ACORN CHROME LUG NUT	14mm - 1.50	13/16"	1.75"
TMRTI155+*	LONG BULGE STYLE ACORN CHROME LUG NUT	14mm - 2.00	13/16"	1.75"

+Denotes special order item.  
\*Item not shown.



## Electrical Cable Ties

Item No.	Description	Pkg. Qty.
TMRBL4+*	BLACK CABLE TIE 4" 18 lb.	100
TMRBL6+*	BLACK CABLE TIE 6" 40 lb.	100
TMRBL8+*	BLACK CABLE TIE 8" 50 lb.	100
TMRBL8W+*	BLACK WIDE CABLE TIE 8" 120 lb.	100
TMRBL11+*	BLACK CABLE TIE 11" 50 lb.	100
TMRBL14+*	BLACK CABLE TIE 14" 50 lb.	100
TMRBL14W+*	BLACK WIDE CABLE TIE 14" 120 lb.	100
TMRBL17W+*	BLACK EXTRA WIDE CABLE TIE 17" 175 lb.	100
TMRBL24+*	BLACK EXTRA WIDE CABLE TIE 24" 175 lb.	50
TMRCCL24+*	NATURAL CABLE TIE 24" 175 lb.	50

+Denotes special order item.  
\*Item not shown.

## Spare Tire Removal Kit & Keys

Item No.	Description
TMRTI8435+	SPARE TIRE REMOVAL KIT, includes: T18410 - Blue Pin Head T18430 - Green 12mm Square Head T18460 - Black Slotted Square Head T18400 - Red Flat Head T18420 - Yellow Hex Head T18440 - Orange Std. Square Head T18480 - Purple 3/8" Square Head T18470 - Hanging Rack

+Denotes special order item.

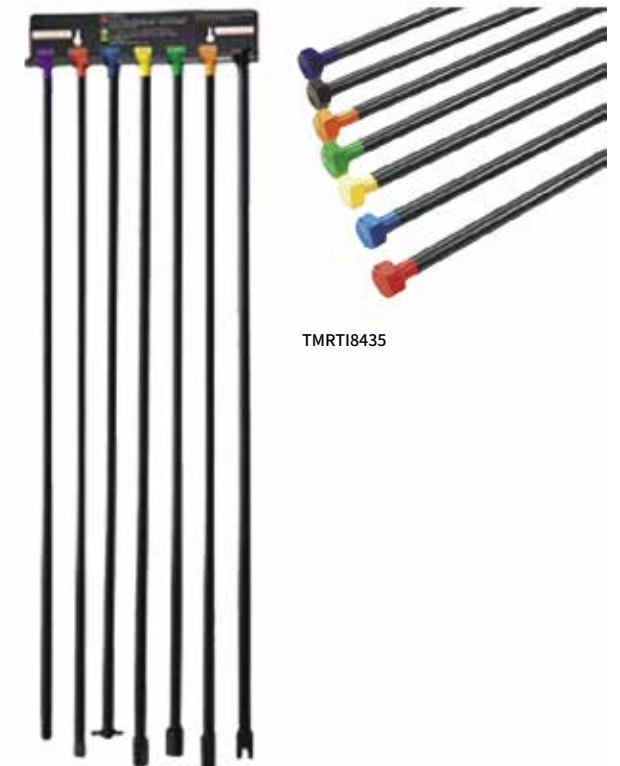

SERVICE TOOLS & EQUIPMENT



# TECH Abrasives

## Aluminum Oxide Disc - Sandpaper

Item No.	Description	Pkg. Qty.
TECH215-100+	2" ALUMINUM OXIDE DISC - 36 GRIT	100
TECH225-100+	2" ALUMINUM OXIDE DISC - 50 GRIT	100
TECH235-100+	2" ALUMINUM OXIDE DISC - 80 GRIT	100
TECH245-100+	2" ALUMINUM OXIDE DISC - 120 GRIT	100
TECH325-50+	3" ALUMINUM OXIDE DISC - 50 GRIT	50

+Denotes special order item.

## Surface Conditioning Discs - Resin Fiber

Item No.	Description	Pkg. Qty.
TECH197-50+	2" SURFACE CONDITIONING DISC coarse grit, brown	50
TECH397-50+	2" SURFACE CONDITIONING DISC fine grit, blue	50
TECH17-25+	3" SURFACE CONDITIONING DISC coarse grit, brown	25
TECH297-50+	2" SURFACE CONDITIONING DISC medium grit, maroon	50
TECH27-25+	3" surface conditioning disc medium grit, maroon	25

+Denotes special order item.

## Blue Zirconia Discs

Item No.	Description	Pkg. Qty.
TECH204-100+	2" BLUE ZIRCONIA DISC - 50 GRIT	100

+Denotes special order item.

## Green Zirconia Discs

Item No.	Description	Pkg. Qty.
TECH305-100+	2" GREEN ZIRCONIA DISC - 24 GRIT	100
TECH306-100+	2" GREEN ZIRCONIA DISC - 36 GRIT	100
TECH309-50+	3" GREEN ZIRCONIA DISC - 36 GRIT	50

+Denotes special order item.

## Arbors

Item No.	Description	Pkg. Qty.
TECH20+	3" ARBOR ROLOC TYPE HOLDER	Ea.
TECH200+	2" ARBOR ROLOC TYPE HOLDER	Ea.

+Denotes special order item.



# TECH Regroovers, Blades & Accessories

## Regroovers, Blades & Accessories

Item No.	Description
S145A (110V)	REGROOVER for cutting tread design into repaired tire. Complete with heat adjustable transformer for reliable cutting speed and control, 110 volts.
S145B (220V)	Same as S145A except 220 volts.
BLADES	S145A & S145B REGROOVER BLADES
S145/R-1	ROUND $\frac{5}{64}$ ", 2mm cutting width
S145/R-2	ROUND $\frac{1}{8}$ ", 3mm cutting width
S145/R-3	ROUND $\frac{13}{64}$ ", 5mm cutting width
S145/R-4	ROUND $\frac{9}{32}$ ", 7mm cutting width
S145/R-5	ROUND $\frac{23}{64}$ ", 9mm cutting width
S145/W-1	WIDE $\frac{5}{64}$ ", 2mm cutting width
S145/W-2	WIDE $\frac{5}{32}$ ", 4mm cutting width
S145/W-3	WIDE $\frac{1}{4}$ ", 6mm cutting width
S145/W-4	WIDE $\frac{5}{16}$ ", 8mm cutting width
S145/W-5	WIDE $\frac{13}{32}$ ", 11mm cutting width
S145/W-6	WIDE $\frac{7}{8}$ ", 22mm cutting width

S145A-IND REGROOVER WITH W-6 BLADES

Repair parts available for S145A and S145B.  
NOTE: Safety feature, S145 Regroovers are pressure activated.



## Rillfit Regroovers, Blades & Accessories

Item No.	Description
S146A	RILLFIT REGROOVER, 110 volt
S146B	RILLFIT REGROOVER, 220 volt
S146/R-1	ROUND BLADE, $\frac{5}{64}$ ", 2mm cutting width, 20/pk.
S146/R-2	ROUND BLADE, $\frac{1}{8}$ ", 3mm cutting width, 20/pk.
S146/R-3	ROUND BLADE, $\frac{13}{64}$ ", 5mm cutting width, 20/pk.
S146/R-4	ROUND BLADE, $\frac{9}{32}$ ", 7mm cutting width, 20/pk.
S146/R-5	ROUND BLADE, $\frac{23}{64}$ ", 9mm cutting width, 20/pk.
S146/W-1	ANGLE BLADE, $\frac{5}{64}$ ", 2mm cutting width, 20/pk.
S146/W-2	ANGLE BLADE, $\frac{5}{32}$ ", 4mm cutting width, 20/pk.
S146/W-3	ANGLE BLADE, $\frac{1}{4}$ ", 6mm cutting width, 20/pk.
S146/W-4	ANGLE BLADE, $\frac{5}{16}$ ", 8mm cutting width, 20/pk.
S146/W-5	ANGLE BLADE, $\frac{13}{32}$ " cutting width, 20/pk.
S146/W-6	ANGLE BLADE, $\frac{7}{8}$ ", 22mm cutting width, 20/pk.



# TECH Tire Spreaders

## Manual Tire Spreaders



Item No.	Description
GTS-01	TRUCK TIRE SPREADER, spread capacity 2"-15" (5cm-38cm)
KEN31551	MANUAL SPREADER WITH LOCK PIN, spread capacity 4"-6" (10cm-15cm)
KEN31554	RATCHETING TIRE SPREADER, spread capacity 4"-6" (10cm-15cm)

## Air Powered Tire Spreader

For Passenger & Truck Tires from 13" to 24.5" rim diameter. Spreads passenger, truck and bus tires for inspection or repair. Foot control valve conveniently located at base of machine. Adjustable light. Convenient tool tray can be mounted on either side of the tire spreader. Spread hooks adjust with spring-loaded pins.



Item No.	Description	Shipping Weight
BRA5120+	AIR POWERED TIRE SPREADER	150 lbs. / 68kg

+ Denotes special order item.

## Passenger Tire Spreaders



Item No.	Description
PS-1	Manual-operated PASSENGER/LIGHT TRUCK SPREADER WITH LIGHT. Can be adjusted to fit a whole range of passenger and light truck tires.
982	TIRE SPREADER

## Tire Repair Station For Passenger & Truck Tires

If you're looking for a stable, reliable tire repair station, the 5500 has all the features you're looking for at an affordable price. Tool tray pivots to either side on machine. Tire spread control conveniently located on both sides of platform top. Foot controls for raising/lowering platform are located on both sides of the machine. Tire ramp retracts automatically when platform is raised. 5 1/4" air cylinder lift platform using as little as 75 psi.



Item No.	Description	Shipping Weight
BRA5500+	TIRE REPAIR STATION for passenger & truck tires	375 lbs. / 170.01kg

+ Denotes special order item.

# TECH Worker Safety & Protection Items

## Repair Light & Eye Protection



Item No.	Description
S1055N	FLUORESCENT REPAIR LIGHT, 110V only, 25 ft., 7.5m power cord
S918*	SAFETY GLASSES, fit over most prescription eyeglasses
S920*	SAFETY GOGGLES, side top and breathing vents
S923	SAFETY GLASSES, clear lenses with padded spatula temples for comfort. Meets ANSI standards.
S924	SAFETY GLASSES, gray shaded lenses with padded spatula temples for comfort. Meets ANSI standards.
S925	CHEMICAL SPLASH & CUTTING GOGGLES, with blue translucent flexible frames & clear anti-fog lens
S1056*	REPLACEMENT FLUORESCENT BULB for S1055N

\*Item not shown

## Safety Gloves

Item No.	Description	Box Qty.
TEC-AXFG-16-009	AX360 FLX GRIP GLOVE, medium	12
TEC-AXFG-16-010	AX360 FLX GRIP GLOVE, large	12
TEC-AXFG-16-011	AX360 FLX GRIP GLOVE, x-large	12



## TECH Hand Cleaners



Item No.	Description
730	TECH MEDICATED HAND CLEANER, 4.5 lb., 2.05kg can
730C	TECH CITRUS MEDICATED HAND CLEANER, 4.5 lb., 2.05kg can
731	DISPENSER for 730 and 732 Hand Cleaner cans
732	TECH PUMICE HAND CLEANER, 4.5 lb., 2.05kg can
732C	TECH CITRUS PUMICE HAND CLEANER, 4.5 lb., 2.05kg can
743	TECH SOY HAND CLEANER, 72 oz., 2125ml
743SP*	TECH SOY HAND CLEANER STARTER KIT, Dispenser Pump and 72 oz., 2125ml Soap

\*Item not shown



# Wheel & Tire Supplies

Designed to extend the usable life of a tire, to reduce the chance of tire failures and to save on fuel costs, proper air pressure must constantly be maintained. TECH's complete lineup of tire and tube valves, TPMS systems and wheel balancing products ensure that all tires will perform to the exacting standards as set forth by the respective tire manufacturers, the Rubber Manufacturer's Association and the Tire Industry Association.



# Introducing the First Dual Frequency, Configurable and Programmable TPMS Sensor

## TECH HYBRID 2.0



The World's Only Single SKU Solution

315 MHz and 433MHz frequencies in one

1-3 Sec **Fastest** configuration on the market

97% **Vehicle Coverage**

**Programmable Updates**

**7 Year Maxell battery**

**3 Year warranty**

## The Next Generation TPMS Sensor

## TECH TPMS Solutions

### TPMS Sensors

Item No.	Description	Box Qty.
TECH6-A66DG	TECH HYBRID 2.0 TPMS SENSOR	1

### TPMS Snap-In Valves

Item No.	Description	Box Qty.
TECH6-209E*	REPLACEMENT Snap-In Valve for U-Pro/OE-R	10
TECH6-207	Snap-In Valve for Schrader Rev. 4	10
TECH6-207C*	Chr Snap-In Valve for Schrader Rev. 4	10
TECH6-208	Snap-In Valve for VDO TG1D	10
TECH6-209D-1	Snap-In Valve for U-Pro/OE-R Sensors	10
TECH6-209D-1C*	Chr Snap-In Valve for U-Pro/OE-R Sensors	10
TECH6-210	Snap-In Valve for Schrader EZ-Sensor	10
TECH6-210H	Snap-In HS Valve for Schrader Bx10	10
TECH6-211	Snap-In Valve for TRW Sensor Ver. 4	10
TECH6-213	Snap-In HS Valve for Schrader Rev. 4	10
TECH6-215A	Snap-In Valve for CUB Multi Sensor	10
TECH6-207B*	Snap-In HS DI Valve for Schrader Bx10	10
TECH6-213B*	Snap-In HS DI Valve for Schrader Bx10	10

\*Item not shown

### TPMS Clamp-In Valves

Item No.	Description	Box Qty.
TECH6-266	Clamp-In Valve for TECH 2.0 and OE-R Sensors	10
TECH6-266BK*	Black Clamp-In Valve for TECH 2.0 and OE-R	10
TECH6-201	Clamp-In Valve for VDO TG1B	10
TECH6-203	BR/NI Clamp-In Valve for Schrader Rev. 4	10
TECH6-203B	BR/NI Clamp-In Valve for Schrader HS Sensor	10
TECH6-204	Clamp-In Gen. 1 Valve for HUF-56mm	10
TECH6-206B	Clamp-In Valve for VDO MB	10
TECH6-216	Clamp-In Valve for Schrader Rev. 4	10
TECH6-218	Clamp-In Valve for VDO MB	10
TECH6-220B	Clamp-In Gen. 1 Valve for HUF-43mm	10
TECH6-225	Clamp-In Valve for Schrader Rev. 5	10
TECH6-228*	Clamp-In Valve for Schrader Gen. A	10
TECH6-228T	Clamp-In Valve Stem for Schrader Gen. A	10
TECH6-230*	Clamp-In Valve for U-Pro/OE-R Sensors	10
TECH6-230BK	Black Clamp-In Valve for U-Pro/OE-R Sensors	10
TECH6-231C	Clamp-In Valve for VDO TG1C	10
TECH6-235	Clamp-In Valve for Schrader Gen. G	10
TECH6-236	Clamp-In Valve for TRW Ver. 2	10
TECH6-240	Clamp-In Gen. 2 Valve for HUF-43mm	10

\*Item not shown





## TECH TPMS Solutions Service Kits

Item No.	Description	Box Qty.
TECH6-102*	Service Kit for Schrader Gen. J	10
TECH6-103*	Service Kit for Schrader Gen. 2/3	10
TECH6-104*	Service Kit for Schrader Gen. 2/3	10
TECH6-108*	Service Kit for VDO TG1B	10
TECH6-109*	Service Kit for TRW Version 2 Sensor	10
TECH6-110*	Service Kit for HUF Gen. 1 Sensor	10
TECH6-111*	Service Kit Pac LFB1/LFC1 BX10	10
TECH6-112*	Service Kit for Schrader Gen. 2/3	10
TECH6-114*	Service Kit for TRW Version 2 BX10	10
TECH6-115*	Service Kit for VDO TG1B	10
TECH6-116T*	Service Kit for Pac LFB1/LFC1	10
TECH6-117*	Service Kit for Pac LFB1/LFC1 BX	10
TECH6-118*	Service Kit for Schrader Gen. 2/3	10
TECH6-119*	Service Kit for Schrader Gen. 2/3	10
TECH6-120*	Service Kit for Schrader Gen. A	10
TECH6-122*	Service Kit for Schrader Gen. J	10
TECH6-123*	Service Kit for Schrader Gen. 1	10
TECH6-125*	Service Kit for TRW Version 2 Sensor Bx10	10
TECH6-127*	Service Kit for TRW Version 1 Sensor	10
TECH6-129*	Service Kit for VDO TG1B	10
TECH6-138*	Service Kit for VDO TG1C	10
TECH6-139*	Service Kit for VDO TG1C	10
TECH6-152*	Service Kit for U-Pro	10
TECH1-1400-1	Box of 100 Nickel Valve Cores	100
TECH2-128	Box of 100 TPMS Valve Caps	100

\*Item not shown

### TPMS Tool Kits

Item No.	Description	Box Qty.
TECH6-312	TPMS Pro Service Tool Kit	Ea.
TECH6-313	TPMS Tool Kit and Carry Case	Ea.

### TPMS Torque Tools

Item No.	Description	Box Qty.
TECH3-150	Valve Cr Tq. 4 Nm/3.54 in-lbs	Ea.
TECH3-162	Rat Torque 1.4 Nm/12.39 in-lbs	Ea.
TECH3-162A	0-9 Nm/80 in-lbs Tq & 6 pc. Set	Ea.
TECH3-163	Torque Wrench Kit to 10 Nm/88.5in-lbs	Ea.

### TPMS Hand Tools

Item No.	Description	Box Qty.
TECH3-164	Hamaton Grommet Removal Tool, Red	Ea.
TECH3-172	Hamaton Grommet Pick	Ea.



## TECH TPMS Solutions Programming Tools

### TECH56 Comprehensive TPMS Service Tool

- All-in-one comprehensive TPMS tool for American, European and Asian vehicles.
- Supports all known programmable TPMS sensors and is frequently updated with new features, vehicles and sensors.
- Fast make-model-year selection via VIN scan (North America only).
- Triggers all OEM sensors worldwide, displays all sensor data.
- Provides comprehensive TPMS relearn procedures (incl. indirect/direct).
- Programs all leading aftermarket programmable sensors.
- Displays OBD2 location on tool screen.
- TPMS reset via OBD2 on more than 60% of car models.
- Retrieves and decodes TPMS DTC information on applicable vehicles.
- Tests remote keyless entry (RKE).
- Unlocks ECU for Toyota family of vehicles.



Item No.	Description	Box Qty.
TECH56-1002	TECH56 Comprehensive TPMS Service Tool	Ea.

### TECH46 TPMS Tool with OBD II Module

- Activates and reads TPMS sensors of all vehicle brands.
- Programs Tech U-Pro Hybrid 2.0 sensors within seconds.
- Provides manual, auto, and indirect relearn procedure information.
- OBDII module included with bundle.
- Displays all sensor data in seconds: ID, tire pressure and tire temperature.
- Select vehicles via make, model, year look-up.
- Easy to read 2.8" color display.
- User friendly navigation and command buttons.
- Frequent database updates via PC desktop software.
- Interface in multiple languages.
- Charger and USB cable included.
- Tire Tread Depth Gauge option.



Item No.	Description	Box Qty.
HAM-D045	TECH46 TPMS Tool with OBDII	Ea.

Ask Your Distributor About TPMS Bundle Deals!



## TECH Valve Hardware

- TECH valve hardware is certified according to the Quality Management System for TPMS and Tire Accessories.
- Fulfill the requirements for ISO/TS 16949:2002 certification by TUV SUD Management Services GmbH.
- Each TECH rubber tire valve is etched with a Traceable ID so you can check the production dates without removing the valve from the rim.

### Rubber Snap-In Valves for Passenger & Light Truck – 65 PSI Max

Item No.	TR No.	Description	Effective Length	Pkg. Qty.
TRI413/500	413	SNAP-IN TUBELESS TIRE VALVE for .453 rim hole	1 1/4", 32mm	500
TR413CH/50	413	SNAP-IN TUBELESS TIRE VALVE for .453 rim hole. Chrome sleeve/cap	1 1/4", 32mm	50
TRI414/50*	414	SNAP-IN TUBELESS TIRE VALVE for .453 rim hole	1 1/2", 38mm	50
TRI415/50	415	SNAP-IN TUBELESS TIRE VALVE for .625 rim hole	1 1/4", 32mm	50
TRI418/500	418	SNAP-IN TUBELESS TIRE VALVE for .453 rim hole	2", 51mm	500
TRI425	425	SNAP-IN TUBELESS TIRE VALVE for .625 rim hole	2", 51mm	1

\*Item not shown.



### TPMS Replacement Valve

Item No.	Description	Pkg. Qty.
TRI20008	RUBBER SNAP-IN STEM with T10 torx head screw	1



### High Pressure Snap-In Valves – 100 PSI Max

Item No.	TR No.	Description	Effective Length	Pkg. Qty.
VHI600HP*	600HP	HIGH PRESSURE TUBELESS RUBBER VALVE for .453 rim hole	1 1/4", 32mm	1
VH602HP*	602HP	HIGH PRESSURE TUBELESS RUBBER VALVE for .453 rim hole	2", 51mm	1
VHI801HP*	801HP	HIGH PRESSURE TUBELESS RUBBER VALVE for .625 rim hole	1 1/4", 33mm	1

\*Item not shown.

## TECH Valve Hardware

### Clamp-In Valves For Passenger & High Performance 150 PSI Max

Item No.	TR No.	Description	Effective Length	Pkg. Qty.
VHI521MS*	416	CLAMP-IN PASSENGER VALVE	1 1/4", 31mm	1
VHI638*	-	ENKEI VALVE STRAIGHT	1 1/2", 38mm	1
VHI651-45*	-	ENKEI VALVE 45°	2", 50mm	1
VHI657	-	ENKEI VALVE STRAIGHT	2 1/4", 57mm	1
VHI407*	-	METAL CLAMP-IN CHROME INNER MOUNT VALVE, 6mm valve hole	1 1/2", 39.5mm	1

\*Item not shown.



VHI657

### Clamp-In Valves For Ford Light Truck – 150 PSI Max

Item No.	Description	Effective Length	Pkg. Qty.
VHIV416-20/BG*	FORD OE VALVE F-SERIES DUAL WHEEL	A = 1", 25mm B = 1.1", 28mm	10

\*Item not shown.



VHI42NI

### High Performance Tubeless Tire Valves

Item No.	Description	Effective Length	Pkg. Qty.
VHIEV37NI-N	NICKEL PLATED VALVE, with special long nut, 11mm hex and 16mm length. Slotted flat bottom.	1 1/2", 37mm	1
VHIEV42NI	NICKEL PLATED VALVE, with special long nut, 14mm hex and 16mm length.	1 3/4", 42mm	1

VHIEV37NI-N



TRI412

TRI412L

### Tubeless Valves for Motorcycles & Scooters

Item No.	Description	Effective Length	Pkg. Qty.
TRI412	SNAP-IN TUBELESS SCOOTER VALVE with 90° bend. For 8.8 rim hole	7/8", 25mm	1
TRI412L	SNAP-IN TUBELESS VALVE w/90° bend	A = 1 1/4", 31mm B = 1 1/4", 30mm	1
VHI401	SNAP-IN VALVE FOR MOTORCYCLES, RALLY VEHICLES & INDUSTRIAL VEHICLES. For .453 rim hole	A = 1 1/4", 30mm B = 1 1/4", 30mm	1
VHI430A	CLAMP-IN TUBELESS NICKEL-PLATED METAL VALVE for rim hole .327"-.339", 8.3mm-8.6mm	1 1/4", 30mm	1



VHI401



VHI430A



# TECH Valve Hardware

## Clamp-In Brass Truck Valves – 150 PSI Max

Item No.	TR No.	Description	Effective Length	Pkg. Qty.
VHI722MS	575	TUBELESS BRASS STRAIGHT TRUCK VALVE	1 1/4", 30mm	1
VHI723MS/BG*	501	TUBELESS BRASS STRAIGHT TRUCK VALVE	1 1/2", 40mm	10
VHI724-23/BG*	500	TRUCK VALVE with 23° bend	A = 1", 26mm B = 1", 26mm	10
VHI724MS/BG	500	TUBELESS BRASS STRAIGHT TRUCK VALVE	2", 50mm	10
VHI725MS/BG*	570	TUBELESS BRASS STRAIGHT TRUCK VALVE	3 1/8", 80mm	10
VHI72590	570	CLAMP-IN TUBELESS BRASS VALVE with 90° bend	A = 1 1/4", 33mm B = 2", 50mm	10
VHI726MS/BG*	571	TUBELESS BRASS STRAIGHT TRUCK VALVE	3 3/8", 85mm	10
VHI72690	571C	CLAMP-IN TUBELESS BRASS VALVE with 90° bend	A = 1 1/4", 33mm B = 2 1/4", 58mm	1
VHI727MS/BG*	572	TUBELESS BRASS STRAIGHT TRUCK VALVE	3 3/4", 95mm	10
VHI72790*	572C	CLAMP-IN TUBELESS VALVE with 90° bend	A = 1 1/4", 33mm B = 2 1/2", 67mm	1
VHI728MS/BG*	573	TUBELESS BRASS STRAIGHT TRUCK VALVE	4 3/8", 110mm	10
VHI72890	573C	CLAMP-IN TUBELESS BRASS VALVE with 90° bend	A = 1 1/4", 33mm B = 3 1/4", 83mm	1
VHI729MS/BG*	574	TUBELESS BRASS STRAIGHT TRUCK VALVE	5", 128mm	10

\*Item not shown.



## TR540 Series Nickel Plated Truck Valves – 150 PSI Max

Item No.	TR No.	Description	Effective Length	Pkg. Qty.
VHI542	542	STRAIGHT TRUCK VALVE	1 1/4", 32mm	1
VHI543/BG*	543	STRAIGHT TRUCK VALVE	2 1/4", 59mm	10
VHI543C/BG*	543C	TRUCK VALVE with 45° bend	A = 15/16", 24mm B = 1 3/8", 35mm	10
VHI543D/BG	543D	TRUCK VALVE with 60° bend	A = 1", 25 mm B = 1 3/8", 35 mm	10
VHI543E/BG	543E	TRUCK VALVE with 75° bend	A = 1", 25mm B = 1 3/8", 35mm	10
VHI544/BG*	544	STRAIGHT TRUCK VALVE	2 3/4", 73mm	10
VHI734/BG*	544D	TRUCK VALVE with 60° bend	A = 1", 25mm B = 2", 49mm	10
VHI544E/BG*	544E	TRUCK VALVE with 75° bend	A = 1", 25mm B = 2", 49mm	10
VHI545/BG*	545	STRAIGHT TRUCK VALVE	3 1/2", 89mm	10
VHI545E/BG	545E	TRUCK VALVE with 75° bend	A = 1", 25mm B = 2 1/2", 66mm	10
VHI736/BG	545D	TRUCK VALVE with 60° bend	A = 1", 25mm B = 2 1/2", 66mm	10
VHI546/BG*	546	STRAIGHT TRUCK VALVE	4 1/4", 108mm	10
VHI546D/BG	546D	TRUCK VALVE with 60° bend	A = 1", 25mm B = 2 1/2", 66mm	10
VHI546E/BG	546E	TRUCK VALVE with 75° bend	A = 1", 25mm B = 3 1/4", 85mm	10

\*Item not shown.



# TECH Valve Hardware

## VH550 Series Valve Stems – 150 PSI Max

VH550 SERIES VALVES for Aluminum Truck Wheels (9.7mm valve hole, 150 psi max). Replaces VH540 series valve with a superior grommet seal design for longer sealing life, greater corrosion resistance, higher temperature range and greater tear resistance. Slotted hex base for easier installation.

Item No.	TR No.	A	Bend	B	Nut	Pkg. Qty.
VH552+	552	1.26	-	-	HN-22	1
VH553+*	553	2.4	-	-	HN-22	1
VH553C	553C	.93	45°	1.43	HN-22	1
VH553E*	553E	.98	75°	1.38	HN-22	1
VH554D	554D	.98	60°	1.94	HN-22	1
VH555D*	555D	.98	60°	2.6	HN-22	1
VH555E*	555E	.98	75°	2.6	HN-22	1

+Replacement grommet Cat. No. HALG-550  
\*Item not shown.



## Nickel Plated Truck Valve Stems – 150 PSI Max

Item No.	TR No.	Description	Effective Length	Pkg. Qty.
VHI755/BG*	511	TUBELESS ALUMINUM DISC VALVE STEM with 90° bend	4.25", 108mm	10
VHI756/BG	509	TUBELESS ALUMINUM DISC VALVE STEM with 90° bend	4.75", 121mm	10
VHI758/BG*	510	TUBELESS ALUMINUM DISC VALVE STEM with 90° bend	5.5", 140mm	10

\*Item not shown.



## European Style Nickel Plated Truck Valves – 150 PSI Max

Item No.	Description	Effective Length	Pkg. Qty.
VHIN321	V3-20-1 NICKEL TRUCK	1 1/2", 36mm	1
VHIN3221	V3-22-1-NICKEL O-RING SEAL CLAMP-IN with 45° bend	A = 1", 25 mm B = 1.1", 28 mm	1
VHIN324-27	V3-20-4 NICKEL TRUCK VALVE with 27° bend	A = 1", 25 mm B = 1 1/2", 60 mm	1
VHIN325-27*	V3-20-5 NICKEL TRUCK VALVE with 27° bend	A = 1", 25 mm B = 1 1/2", 40 mm	1
VHIN327-27*	V3-20-7 NICKEL TRUCK VALVE with 27° bend	A = 1", 25 mm B = 2", 50 mm	1

\*Item not shown.



# TECH Valve Hardware

## European Style Brass Truck Valves – 150 PSI Max

Item No.	Description	Effective Length	Pkg. Qty.
VHIE321	V3-20-1 BRASS TRUCK VALVE with 17.5° bend	1 1/2", 36mm	1
VHIE32217*	O-RING SEAL CLAMP-IN VALVE METRIC	A = 1 1/4", 30mm B = 2 1/2", 60mm	1
VHIE323*	V3-20-3 BRASS TRUCK VALVE	3 1/4", 82mm	1
VHIE324-27	V3-20-4 BRASS TRUCK VALVE with 27° bend	A = 1", 25mm B = 2 1/2", 60mm	1
VHIE325-27*	V3-20-5 BRASS TRUCK VALVE with 27° bend	A = 1", 25mm B = 1 1/2", 40mm	1
VHIE326-27	V3-20-6 BRASS TRUCK VALVE with 27° bend	A = 1", 25mm B = 3 1/4", 85mm	1
VHIE327-27	V3-20-7 BRASS TRUCK VALVE with 27° bend	A = 1", 25mm B = 2", 50mm	1

\*Item not shown.



VHIE326-27 VHIE324-27 VHIE327-27 VHIE321

## European-Style Clamp-In Valves for Truck & Bus – 150 PSI Max

Item No.	Description	Effective Length	Pkg. Qty.
VHIV3121	EURO SINGLE BEND TUBELESS VALVE	A = 1 1/2", 40mm	1
VHIV3131	EURO DOUBLE BEND TUBELESS VALVE with 153° bend	A = 1 3/4", 46.5mm B = 1 3/4", 46.5mm	1
VHIV3141*	EURO TRIPLE BEND TUBELESS VALVE	B = 1", 26mm	1

\*Item not shown.

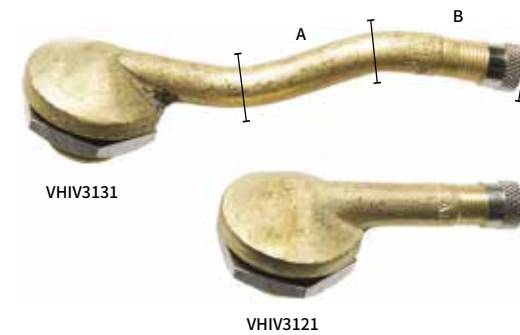

VHIV3121

VHIV3131

## Valve Caps

Item No.	Description	Pkg. Qty.
VHICAPS	PLASTIC VALVE DUST CAPS, long version	100
VHI53/1	NICKEL PLATED, LONG METAL DOME SEALING CAP	100
VHI53/1S	SHORT METAL DOME SEALING CAP	1
VH60GRY	PLASTIC SEALING CAP GREY	100
VH60GRN*	PLASTIC SEALING CAP GREEN	100
VH656/58	ADAPTOR CAP to convert large bore to standard bore with cap	1
VHIVC2	NICKEL PLATED METAL SCREWDRIVER SEALING CAP	1
VHIVC8-G	LONG PLASTIC DUST CAP GREEN	1
VH82	DOUBLE SEAL VALVE CAP extends valve 1/2", 13mm OAL	100

\*Item not shown.



VHIVC8-G

VH60GRY

VHICAPS

VH82



# TECH Valve Hardware

## Valve Cores

Item No.	Description	Pkg. Qty.
VHI430HT/1	TRC-1 HEAT RESISTANT VALVE CORE, temperature range -40°F to 284°F (-40°C to 140°C)	100
VH430HT-F	FILTERED VALVE CORE 20, high temp (shown above)	20
VHJ440	TRC-2 LONG LARGE BORE VALVE CORE	1
VHJ450	TRC-2 LARGE BORE VALVE CORE	1



VHJ440

VHJ450

VH430HT-F

VHI430HT/1

## Grommets

Item No.	TR No.	Description	Pkg. Qty.
VH822	TRG-46	REPLACEMENT GROMMET for VH755, VH756 and VH758 valves	1
VH823	RG-15	REPLACEMENT GROMMET for VH720 series tubeless truck tire valves	1
HALG-170S+	-	HIGH TEMP SILICONE REPLACEMENT GROMMET for VH720 series tubeless truck tire valves. Maximum temp. 400°F, 204°C.	1
VHJ829	RG-22	REPLACEMENT GROMMET for VHJSP2 tubeless spud	1

+Denotes special order item.



VH823

VH822

VHJ829

## Passenger Plastic Valve Extensions

Item No.	Description	Length	Pkg. Qty.
VH34	PLASTIC VALVE EXTENSION	3/4", 20mm	100
VH35	PLASTIC VALVE EXTENSION	1 1/4", 30mm	100
VH36	PLASTIC VALVE EXTENSION	1 1/2", 40mm	100
VH37	PLASTIC VALVE EXTENSION	2", 50mm	50

\*Item not shown.



VH34

VH35

VH36

VH37

## Plastic Truck Valve Extensions

Item No.	Description	Length	Pkg. Qty.
VHIBLE34TP	PLASTIC TRUCK VALVE EXTENSION	1 1/2", 33.5mm	1
VHIBLE78TP*	PLASTIC TRUCK VALVE EXTENSION	3", 77mm	1
VHIBLE98TP	PLASTIC TRUCK VALVE EXTENSION	3 3/4", 97.5mm	1
VHIBLE108TP*	PLASTIC TRUCK VALVE EXTENSION	4 1/4", 107.5mm	1
VHIBLE133TP*	PLASTIC TRUCK VALVE EXTENSION	5 1/4", 132.5mm	1
VHIBLE153TP	PLASTIC TRUCK VALVE EXTENSION	6", 152.5mm	1
VHIBLE163TP*	PLASTIC TRUCK VALVE EXTENSION	6 1/4", 162.5mm	1

\*Item not shown.



VHIBLE34TP

VHIBLE98TP

VHIBLE153TP

VHIBLE34B90

VHIBLE29B45

## Brass Truck Valve Extensions

Item No.	Description	Length	Pkg. Qty.
VHIBLE29B45	BRASS TRUCK VALVE EXTENSION with 45° bend	1 1/4", 29mm	1
VHIBLE34B90	BRASS TRUCK VALVE EXTENSION with 90° bend	1 1/2", 34mm	1



# TECH Valve Hardware

## Metal Valve & Rigid Extensions

Item No.	Description	Length	Pkg. Qty.
VH601	METAL VALVE EXTENSION	1/2", 13mm	1
VH602	METAL VALVE EXTENSION	3/4", 20mm	1
VH603	METAL VALVE EXTENSION	1 1/4", 30mm	1
VH643	STRAIGHT METAL TRUCK VALVE EXTENSION	3", 75mm	1
VH645	STRAIGHT METAL TRUCK VALVE EXTENSION	5", 125mm	1
VH646	STRAIGHT METAL TRUCK VALVE EXTENSION	6", 150mm	1

\*Item not shown.



## Flexible Rubber Valve Extensions

Item No.	Description	Length	Pkg. Qty.
VHIFVE125*	RUBBER VALVE EXTENSION	4.92", 125mm	1
VHIFVE140	RUBBER VALVE EXTENSION	5.5", 140mm	1
VHIFVE160*	RUBBER VALVE EXTENSION	6.3", 160mm	1
VHIFVE180	RUBBER VALVE EXTENSION	7.09", 180mm	1
VHIFVE210*	RUBBER VALVE EXTENSION	8.25", 210mm	1
VHIFVE250	RUBBER VALVE EXTENSION	9.84", 250mm	1
VHIFVE280*	RUBBER VALVE EXTENSION	11.03", 280mm	1

\*Item not shown.



## Stainless Steel Braided Flexible Rubber Valve Extensions

Item No.	Description	Length	Pkg. Qty.
VHIFVE160B*	METAL BRAIDED FLEXIBLE VALVE EXTENSION	6.3", 160mm	1
VHIFVE180B	METAL BRAIDED FLEXIBLE VALVE EXTENSION	7", 180mm	1
VHIFVE210B	METAL BRAIDED FLEXIBLE VALVE EXTENSION	8.25", 210mm	1
VHIFVE250B*	METAL BRAIDED FLEXIBLE VALVE EXTENSION	10", 250mm	1
VHIFVE270B	METAL BRAIDED FLEXIBLE VALVE EXTENSION	10.64", 270mm	1

\*Item not shown.



## Valve Extension Holder

Item No.	Description	Pkg. Qty.
VHIBLH11	SINGLE HOLDER FLEXIBLE VALVE EXTENSION	1
VHIBLH21	DOUBLE HOLDER FLEXIBLE VALVE EXTENSION	1
VHIBLH22	DOUBLE HOLDER FLEXIBLE VALVE EXTENSION	1



# TECH Tractor, Grader & Large Bore Valves

- Tech offers a complete line of valves for agricultural, grading, material handling and earthmoving applications – anywhere liquid ballast is used.
- Designed to simplify air-liquid service and provide long, dependable life.
- Large Bore Valves are designed for when faster inflation times or air/liquid inflation are required.

## Tractor/Grader Valves/Core Housings & Extensions

Item No.	TR No.	Description	Effective Length	Pkg. Qty.
VH580	621A	LARGE BORE TUBELESS AIR-LIQUID VALVE for .625 valve hole	4 1/2", 115 mm with 65° bend	1
VH582	622A	LARGE BORE TUBELESS AIR-LIQUID VALVE for .625 valve hole	6 1/4", 155 mm with 90° bend	1
VH584	623A	LARGE BORE AIR-LIQUID VALVE .625 valve hole	3 3/4", 95 mm with 65° bend	1
VH1594	CH-3	AGRI-CORE HOUSING for air-liquid valves		1
VH1595	CH-1	AGRI-CORE HOUSING, OLD TYPE		1
VH1597		AIR-LIQUID VALVE EXTENSION	2 3/4", 70 mm	1
VH1596	618A	LARGE BORE TUBELESS AIR-LIQUID VALVE for .625 valve hole	2", 50mm, straight	1
VH936A*	453	FRONT TUBELESS TRACTOR VALVE for .453 rim hole	9/16", 14mm	1
VH936B*	625	FRONT TUBELESS TRACTOR VALVE for .625 rim hole	9/16", 14mm	1

\*Item not shown



## Large Bore Swivel Valve Stems & Straight Valve Stems

For Use With VHJSP2 Tubeless Spud & VHJAD4 Swivel Adaptor

Item No.	TR No.	Description	Effective Length	Pkg. Qty.
VHIJ651*		LARGE BORE SWIVEL TYPE VALVE STEM with single 90° bend	A = 1 1/4", 32mm B = 4 3/4", 119mm	1
VHIJ652		LARGE BORE SWIVEL TYPE VALVE STEM with single 86° bend	A = 1 1/16", 27mm B = 5 1/2", 140mm	1
VHIV5101		TUBELESS SPUD fits 13/16", 20.5mm rim hole. Use with all large bore swivel valves.		1

\*Item not shown

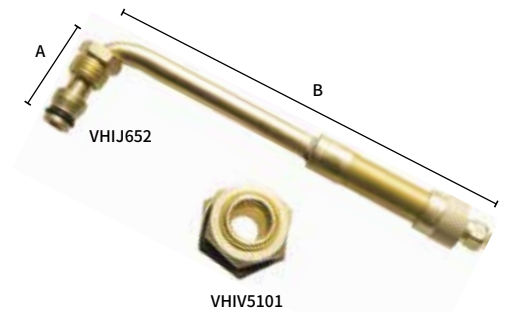

## Large Bore Swivel Valve Stems

For Use With VHJSP2 Tubeless Spud & VHJAD4 Swivel Adaptor

Item No.	TR No.	Bend Angle	Horizontal Length	Vertical Height	Pkg. Qty.
VHJ4450	J-4000-4 1/2	90°	4 1/2", 115mm	1 5/64", 27mm	1
VHJ4600	J-4000-6	90°	6", 150mm	1 5/64", 27mm	1
VHJ4750	J-4000-7 1/2	90°	7 1/2", 190mm	1 5/64", 27mm	1
VHJ4900	J-4000-9	90°	9", 230mm	1 5/64", 27mm	1



## Large Bore Turret Valve Stem, Tank Valve, Swivel Valve Adaptor & Tubeless Spud

Item No.	TR No.	Description	Pkg. Qty.
VHB9A	B9A	Fits TR-218A and TR-220A valves to allow use of valve in the 13/16" valve hole	1
VHJAD4	TRAD4	SWIVEL VALVE ADAPTOR converts tubes with SP-1000 type spud to accept large bore swivel valves	1
VHJSP2	SP-2	TUBELESS SPUD TR-SP2 fits 13/16" rim hole, used with all swivel large bore valves	1
VHJ690	J-690	TURRET VALVE for planetary gear wheels	1



# TECH Tractor, Grader & Large Bore Valves

LARGE BORE FLOW Ø .19" / 4.826mm

## Large Bore Extensions



Item No.	Description	Length	Pkg. Qty.
VHJ7678	METAL VALVE EXTENSION, Large Bore	6 <sup>7</sup> / <sub>8</sub> " 175 mm	1
VHJ7734	METAL VALVE EXTENSION, Large Bore	7 <sup>3</sup> / <sub>4</sub> " 195 mm	1
VHJ7900	METAL VALVE EXTENSION, Large Bore	9" 230 mm	1

## Hand Bendable Extensions

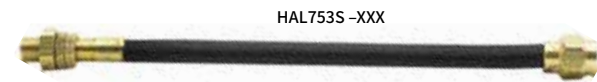

Item No.	Description	Length	Pkg. Qty.
HAL753S-XXX+	LARGE BORE HAND BENDABLE VALVE EXTENSION	Available in lengths 3.5" to 32"	1

+Denotes special order item.

## Custom Bent Swivel Valves for Caterpillar (OE Valves)



Item No.	Description	Length	Pkg. Qty.
HALWHG-8018VC+	SWIVEL VALVE with 4 bends	26 <sup>3</sup> / <sub>4</sub> "	1
HALWHG-8019VC+	SWIVEL VALVE with 1 bend	8"	1

+Denotes special order item.

## Large Bore Valve Caps & Adaptors



Item No.	TR No.	Description	Pkg. Qty.
VHJ59	VC-6	VALVE CAP, large bore, screwdriver top	1
VHJ67	VC-7	HEX TOP for easy tightening and removal	1
VH65558	AD1	LARGE BORE HEXAGON ADAPTOR with cap (inside) converts large bore to standard bore	1
VH65658	-	LARGE BORE ROUND ADAPTOR with cap (outside) converts large bore to standard bore	1

# TECH Super Large Bore Valves & Accessories

SUPER LARGE BORE FLOW Ø .44" / 11.176mm

- Recommended for earthmover applications from 20" up to 57" when faster inflation/deflation times are required.
- Air flow through Super Large Bore Valves is four times faster than large bore valves. There are four key components to the valve and a unique inflator to maximize air flow.

## SLB Swivel Valve & Components

### Complete Super Large Bore Valves

Item No.	Description	Pkg. Qty.
HALM-1950-8*	COMPLETE SWIVEL VALVE ASSEMBLY including R-520 and T81	1
HALM-1900-8*	Same as M-1950-8 but without T-81 spud	1

### Clamp-In Spuds

Item No.	Description	Pkg. Qty.
HALT-81*	TR No. SP8, 1 <sup>3</sup> / <sub>16</sub> " valve hole	1
HALT-82*	Same as T-81 with 1/4" additional length	1

### Swivel Angle Connector

Item No.	Description	Pkg. Qty.
HALR-525*	90° angle, screws on to spud	1
HALR-660*	60° angle (not shown)	1

### Flexible Extension

Item No.	Description	Pkg. Qty.
HALMT-3000*	FLEXIBLE EXTENSION WITH BRASS FITTINGS, 2 B-222 nuts, specify length when ordering. (MT3035 is 35" long) Not shown.	1

### Core Housing

Item No.	Description	Pkg. Qty.
HALR-520*	TR No. CH-8, includes cap and core	1

## Super Large Bore Inflator Adaptor

Reduces inflation time by 60%, deflation time by 80%. Accepts 1/2" NPT for easy air hose connection, extracts valve core. Standard valve stem knob allows air pressure checks during inflation with a tire pressure gauge.

Item No.	Description	Pkg. Qty.
HALIN-80A*	SLB INFLATOR ADAPTOR	1

+Denotes special order item.





# TECH Super Large Bore Valves & Accessories

SUPER LARGE BORE FLOW Ø .44" / 11.176mm

## SLB Valve Assembly Tools

Item No.	Description	Pkg. Qty.
HALT-620+	SLB FIELD ASSEMBLY TOOL	1
HALSLBHAT+	SLB HYDRAULIC ASSEMBLY TOOL (pump not included)	1

+Denotes special order item.



## Super Large Bore Field Assembly Kits

Kits include brass fittings needed to assemble one flexible SLB valve using the T-620 or SLBHAT with a hydraulic pump.

Item No.	Description	Pkg. Qty.
HALR-969K-1+	Includes 1 ea. R762S, R-763, 2 ea. R-764 and B-222	1
HALR-969-K+	Includes above plus 1 R-520 core housing	1
HALR-760-50+	Extension tubing 50' length	1
HALR-760-100+	Extension tubing 100' length	1

+Denotes special order item.



## PT Valve System Components

The PT Valve System allows user to monitor tire pressure with an easy to read, liquid filled dial gauge attached to the valve. Calibrated 0-160 psi.

Item No.	Description	Pkg. Qty.
HALPT-Gauge+	LIQUID-FILLED DIAL GAUGE, easy to read	1
HALPT-EX+	LARGE BORE EXTENSION, allows for PT gauge installation on existing valves. Effective length 1 <sup>5</sup> / <sub>8</sub> "	1
HALPT-300-J-650+	LARGE BORE SWIVEL VALVE with PT grooves and O-ring	1

+Denotes special order item.

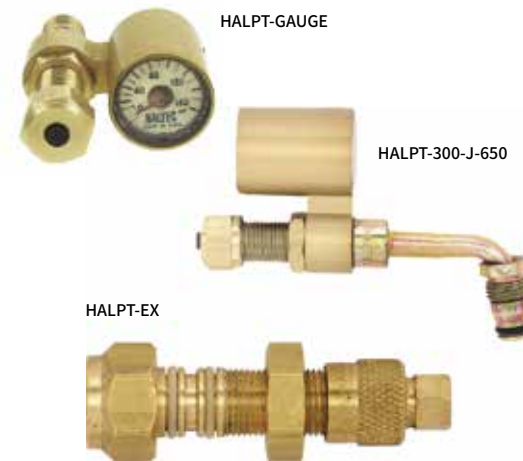

# TECH OTR Tire & Wheel Service Products

## O-Rings

Standard and Arctic O-Rings for tubeless rims are manufactured to OEM specifications for a wide range of multipiece rim O-ring grooves. O-rings are produced in a standard compound for -40°F to 180°F, and Arctic compound for -65°F to 180°F applications.

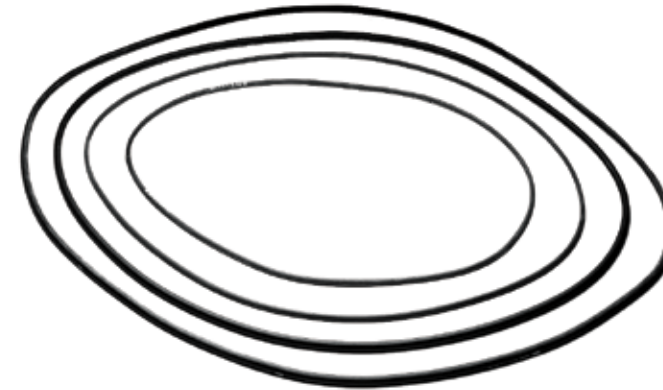

Item No.	Application	Rim Ø	Rod Ø	Qty. Bag / Case
OR24JM	Highway (JM)	24"	.26	2 / 24
OR220TG	Grader	20"	.26	2 / 24
OR224TG	Grader	24"	.26	2 / 24
OR25T	Earthmover (small)	25"	.26	2 / 24
OR325T	Earthmover	25"	.375	2 / 24
OR329T	Earthmover	29"	.375	2 / 24
OR333T	Earthmover	33"	.375	2 / 24
OR335T	Earthmover	35"	.375	2 / 24
OR339T	Earthmover	39"	.375	2 / 24
OR345T	Earthmover	45"	.375	2 / 24
OR349T	Earthmover	49"	.375	2 / 24
OR451T	Earthmover	51"	.50	2 / 24
OR457T	Earthmover	57"	.50	2 / 24
HALOR-215-H+	Grader/Highway	15"	.28	2 / 24

+Denotes special order item  
Add suffix "A" to Cat. No. to order Arctic compound O-rings.

## L-Ring Seals For Earthmover Rims

L-ring seals for earthmover rims help provide an airtight seal between the tire bead and rim bead seat area when the two components are not completely compatible.

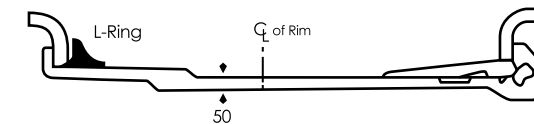

Item No.	Description	Pkg. Qty.
HALLR-25+	25" L-RING SEAL	1
HALLR-29+	29" L-RING SEAL	1
HALLR-33+	33" L-RING SEAL	1
HALLR-35+	35" L-RING SEAL	1

+Denotes special order item

# TECH Valve Repair Tools and Accessories

- Ideal for making valve installations, removal, and repairs easier, simpler and less time consuming.
- Tech has a complete line of valve installation, removal and repair tools to fit any repair person's need.

## Valve Core Repair Tools

Item No.	Description
VH604	2-WAY VALVE REPAIR TOOL, combination valve core driver and deflating pin, deeply knurled for easy handling
VH605	4-WAY VALVE REPAIR TOOL, repairs and reconditions inside and outside valve threads, inserts and removes cores
VH608	HEAVY DUTY 4-WAY VALVE REPAIR TOOL, repairs and reconditions inside and outside valve threads, inserts and removes cores



## Valve Core Installation/Removal Tools

Item No.	Description
VH609	VALVE CORE TORQUE TOOL
VH670	EXTRA LONG VALVE CAP TOOL for hard to reach places
VH673	RED HANDLE VALVE CORE TOOL for standard valve cores
VH674	HEX VALVE CORE TOOL designed for use with wrench while installing & removing valve cores
VH675	RED HANDLE VALVE CORE TOOL for large & standard valve cores
VH683*	LOCKING VALVE CORE TOOL



\*Item not shown

## Valve Installation Tools

Item No.	Description
VH671	QUICK MOUNT/DEMOUNTING VALVE TOOL for snap-in tubeless tire valves
VH672	LEVER MOUNTING TOOL for snap-in tubeless tire valves



## Valve Fishing Tools & Tube Deflators

Item No.	Description
VH606	CABLE-TYPE VALVE FISHING TOOL aids in installation of tube type tires
VH607	CHAIN-TYPE VALVE FISHING TOOL aids in installation of tube type tires
VH3215	TUBE DEFLATOR – single piece screw-on deflator for rapid evacuation of air from tube
VH3216	CLIP-ON, HEAVY-DUTY TUBE DEFLATOR for rapid evacuation of air from tube



# TECH Valve Repair Tools and Accessories

## Valve Core Ejectors & Liquid Filling



Item No.	Description
VH598	AIR WATER ADAPTOR permits filling of tire with fluid or ballast from standard water hose
VH599	TIRE FILLING AND CORE EJECTOR for filling or evacuation of liquid from a tire. 1/2" female pipe thread will attach to calcium tire filling pumps. Adaptors included
VH599RK	REPAIR KIT FOR VH599
HALIN-20*+	PASSENGER TIRE CORE EJECTOR

\*Item not shown  
+Denotes special order item

## Tread Depth Gauges



Item No.	Description
VH666	TREAD DEPTH GAUGE, 3 sides calibrated 0-1" in 1/32" black markings. 3 sides calibrated mm in red markings.
VH666CLR	SAME AS VH666 WITH COLOR CODED SCALE
HALN-1410+	OFF-HIGHWAY TIRE TREAD DEPTH GAUGE calibrated with 32nds on one side, other side in mm. Magnified sight glass for easy readability. Includes carrying holster.
HAL5131+	OTR TREAD DEPTH GAUGE. 2 piece gauge made of slide tube and indicator. Calibrated 0-6" in 1/32" units and 7-152 mm units.

+Denotes special order item



# TECH Passenger Car & Light Truck Clip-on Wheel Weights

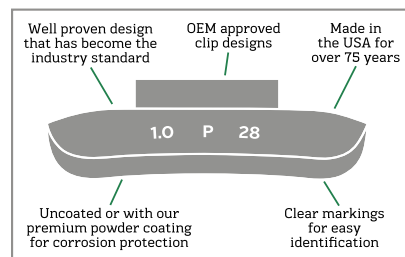

**LEAD FINISH**

**84U-Series: For Steel Wheels**

A new non-lead alternative designed for the aftermarket. Made from high quality zinc material making installation and removal easier.

**63-Series: For Alloy Wheels**

MultiFit® weights come in larger box sizes to help reduce inventory reordering. 63-Series features a 3-year proven powder coating for corrosion protection.

Note that it does not work on LH & EN-Series wheels - use an adhesive weight.

**ZINC FINISH**

A new non-lead alternative designed for the aftermarket. 5-year proven powder coating for corrosion protection.

**STEEL FINISH**

## Wheel Weights Part Number - Description - Weight Range

(When ordering, replace X.XX with required weight)

Series	Rim Profile	Lead	Zinc	Steel
<b>P</b>		<b>P-X.XX</b> 0.25 oz. to 3 oz. / 50 per box 3.25 oz. to 6 oz. / 25 per box	<b>PZU - X.XX</b> 0.25 oz. to 3 oz. 50 per box	<b>PST - X.XX</b> 0.25 oz. to 3 oz. 50 per box
<b>AW</b>		<b>AWN - X.XX</b> 0.25 oz. to 3 oz. 25 per box	<b>AWZ - X.XX</b> 0.25 oz. to 3 oz. 25 per box	<b>AWST - X.XX</b> 0.25 oz. to 3 oz. 25 per box
<b>MC</b>		<b>MCN - X.XX</b> 0.25 oz. to 4 oz. 25 per box	<b>MCZ - X.XX</b> 0.25 oz. to 3 oz. 25 per box	<b>MCST - X.XX</b> 0.25 oz. to 3 oz. 25 per box
<b>LH</b>		<b>H - X.XX</b> 0.25 oz. to 3 oz. 25 per box	<b>LHZ - X.XX</b> 0.25 oz. to 3 oz. 25 per box	<b>LHST - X.XX</b> 0.25 oz. to 3 oz. 25 per box
<b>IAW</b>		<b>IAW - X.XX</b> 5 g to 60 g 25 per box	<b>IAWZ - X.XX</b> 5 g to 60 g 25 per box	<b>IAWST - X.XX</b> 5 g to 60 g 25 per box
<b>EN</b>		<b>EN - X.XX</b> 10 g to 60 g 25 per box	<b>ENZ - X.XX</b> 10 g to 60 g 25 per box	<b>ENST - X.XX</b> 10 g to 60 g 25 per box
<b>FN</b>		<b>FN - X.XX</b> 5 g to 80 g 25 per box	<b>FNZ - X.XX</b> 5 g to 80 g 25 per box	<b>FNST - X.XX</b> 5 g to 60 g 25 per box
<b>TN</b>		<b>TN - X.XX</b> 0.25 oz. to 5 oz. 25 per box	<b>TZ - X.XX</b> 0.25 oz. to 3 oz. 25 per box	<b>TST - X.XX</b> 0.25 oz. to 3 oz. 25 per box

# TECH Medium & Heavy Duty Truck Clip-on Wheel Weights

## Wheel Weights Part Number - Description - Weight Range

(When ordering, replace X.XX with required weight)

Series	Rim Profile	Lead
<b>CT</b>		<b>CT - X.XX</b> 2 oz. to 8 oz. / 25 per box 10 to 12 oz. / 20 per box 14 to 16 oz. / 10 per box
<b>17</b>		<b>17 - X.XX</b> 1 oz. to 8 oz. / 25 per box 10 to 12 oz. / 20 per box 14 to 16 oz. / 10 per box
<b>19</b>		<b>19 - X.XX</b> 2 oz. to 8 oz. / 25 per box 10 to 12 oz. / 20 per box
<b>LT1</b>		<b>LT1 - X.XX</b> 0.5 oz. to 6 oz. 25 per box
<b>RC</b>		<b>RC - X.XX</b> 2 oz. to 8 oz. / 25 per box 10 to 12 oz. / 20 per box
<b>LT1</b>		<b>TAL - X.XX</b> 2 oz. to 8 oz. 25 per box

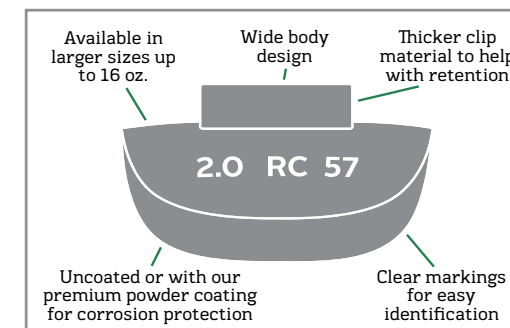

**LEAD FINISH**

## TECH Wheel Weight Hammers



Item No.	Description
<b>976</b>	SOFT HEAD PASSENGER WHEEL WEIGHT HAMMER for installation/removal of coated wheel weights
<b>977</b>	SOFT HEAD WHEEL WEIGHT HAMMER for installation/removal of coated wheel weights, wood handle
<b>978*</b>	PASSENGER WHEEL WEIGHT HAMMER

\*Item not shown.

# TECH QUIKSTIK® Adhesive Wheel Weights

## Lead Adhesive Wheel Weights – Passenger Car & Motorcycle Applications

Item No.	Increments	Width	Size	Profile	Box Qty.
PE100360C (Chrome)*	0.25 oz. (7g)	1/2"	3 oz.	Standard	30
PE100360S (Silver)*	0.25 oz. (7g)	1/2"	3 oz.	Standard	30
PE100720*	0.25 oz. (7g)	1/2"	3 oz.	Standard	60
PE200624*	0.25 oz. (7g)	3/4"	3 oz.	Low	52
PE200624S*	0.25 oz. (7g)	3/4"	3 oz.	Low	48
PE300360*	0.5 oz. (14g)	3/4"	6 oz.	Standard	30
PECL6	1 oz. (28g)	3/4"	6 oz.	Standard	30
PECL12	2 oz. (56g)	1 1/4"	12 oz.	Standard	8

\*Item not shown.

## Lead Adhesive Wheel Weights – Truck Applications

Item No.	Increments	Width	Size	Profile	Box Qty.
PE300360*	0.5 oz. (14g)	3/4"	6 oz.	Standard	30
PECL6	1 oz. (28g)	3/4"	6 oz.	Standard	30
PECL12	2 oz. (56g)	1 1/4"	12 oz.	Standard	8

\*Item not shown.

## Steel Adhesive Wheel Weights

Item No.	Increments	Width	Size	Profile	Box Qty.
PESG060N*	5g	3/4"	60g	Low	25
PESST300N*	0.25 oz. (7g)	3/4"	3 oz.	Standard	25
PE200624ST	0.25 oz. (7g)	1/2"	3 oz.	Low	52
PESM600N*	0.25 oz. (7g)	1"	6 oz.	Standard	30
PE300360ST	0.25 oz. (7g)	1"	6 oz.	Standard	30
PE200576FE*	0.25 oz. (7g)	3/4"	9 lb.	Low	576

\*Item not shown.

## Steel Adhesive Wheel Weight Rolls

Item No.	Segments	Width	Size	Profile	Box Qty.
PE200624STR	0.25 oz. (7g)	1/2"	20 lb.	Low	1250
PESG7500N*	5g	3/4"	16.5 lb.	Low	1500
PESST32000N*	0.25 oz. (7g)	3/4"	20 lb.	Standard	1280
PE300360STR*	0.5 oz. (14g)	1"	20 lb.	Standard	640

\*Item not shown.

## Quikstik® Starter Kits & Stands

Item No.	Description
PESK2000*	QUIKSTIK® STARTER KIT with single roll stand
PESK3000*	QUIKSTIK® STARTER KIT with dual roll stand
PEQS2000	QUIKSTIK® STAND, holds one steel QuikStik® roll
PEQS3000*	QUIKSTIK® DUAL STAND, holds two steel QuikStik® rolls

\*Item not shown.



# TECH Lead Free Balance Pads

- Provides a "green" option of balancing the tire from the inside.
- In special tire service applications, traditional exterior clip on wheel weights may not be enough to correct an out of balance condition or may become dislodged.
- Installation is performed using the combination of a spin balancer and the same procedures as installing a tire repair unit.

Item No.	Description	Box Qty.
1181*	BALANCE PAD, 30 gram	1
1182	BALANCE PAD, 50 gram	1
1183*	BALANCE PAD, 75 gram	1
1184*	BALANCE PAD, 100 gram	1
1185	BALANCE PAD, 125 gram	1
1186*	BALANCE PAD, 150 gram	1
1187*	BALANCE PAD, 175 gram	1
1188	BALANCE PAD, 200 gram	1

\*Item not shown.



# TECH PLUS Tire Balancing Compound

Item No.	Description	Box Qty.
TLP60*	TECH PLUS, 2 oz.	48
TL100*	TECH PLUS, 3 oz.	36
TL150	TECH PLUS, 4.5 oz.	36
TL200*	TECH PLUS, 6.5 oz.	24
TL250*	TECH PLUS, 8.5 oz.	24
TM300*	TECH PLUS, 10.5 oz.	20
TM400*	TECH PLUS, 13 oz.	12
TM500*	TECH PLUS, 16 oz.	12
TP6000*	TECH PLUS, 21 oz.	8
TP7000*	TECH PLUS, 23.5 oz.	8

\*Item not shown.

## How TECH PLUS Works

Thousands of specially coated microbeads reduce friction and maintain durability, giving you the option of reinstalling TECH PLUS in a retreaded truck tire for trailer applications.

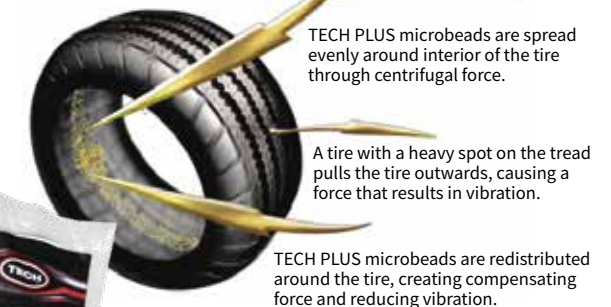

TECH PLUS microbeads are spread evenly around interior of the tire through centrifugal force.

A tire with a heavy spot on the tread pulls the tire outwards, causing a force that results in vibration.

TECH PLUS microbeads are redistributed around the tire, creating compensating force and reducing vibration.



# TECH Tire Sealant

Item No.	Description	Box Qty.
TPTS32*	TECH PREMIUM TIRE SEALANT, 32 oz., 950ml bottle	12
TPTS5	TECH PREMIUM TIRE SEALANT, 5 gal., 19 liter container	1
TPTS55*	TECH PREMIUM TIRE SEALANT, 55 gal., 209 liter drum	1
TPTS275*	TECH PREMIUM TIRE SEALANT, 275 gal., 1040 liter tote	1
IM-10005*	TECH SEALANT PUMP	1

\*Item not shown.





# TECH Repair Manuals & Repair Charts

## Repair Manuals

Item No.	Description
RM-1	TUBE REPAIR
RM-2	VALVE REPAIR
RM-4	250UL & 251UL UNI-SEAL ULTRA REPAIR on a Speed Rated Tire
RM-5	2-PIECE REPAIR
RDVD1	UNI-SEAL & TWO-PIECE NAILHOLE REPAIR DVD



## Repair Charts

The following pages contain a complete inventory of TECH repair application charts for your reference.

To order TECH wall Charts refer to the item numbers below.

Item No.	Title	Description
BP	BP Bias Ply Size of Injury	Large wall chart contains complete information on proper selection of BP bias ply repair units
CT	Centech Size of Injury/Repair Selection Chart	Large wall chart contains complete information on selecting the proper Centech radial repair units for passenger, light truck, medium truck & tractor tires
CTOR	Centech Off Road Repair Selection Chart	Large wall chart contains complete information on selecting the proper Centech radial OTR repair units
PTC	Uni-Seal Ultra Repair Chart	Large wall chart featuring the application of Uni-Seal Ultras in passenger, light truck and truck tires.
2PC	Two-Piece Wall Chart	Large wall chart featuring the application of Two-Piece style repairs in passenger, light truck and truck tires.
TOR	TOR Wall Chart	Large wall chart contains complete information on selecting the proper Tech TOR repair unit for off-road tires.
VHSC	TECH Valve Hardware Selection Chart	Large wall chart contains complete information on selecting proper valve hardware for passenger, light truck and medium truck applications.



# TECH Uni-Seal Ultra, Uni-Seal Ultra Max & Bias Uni-Seal Repair Applications

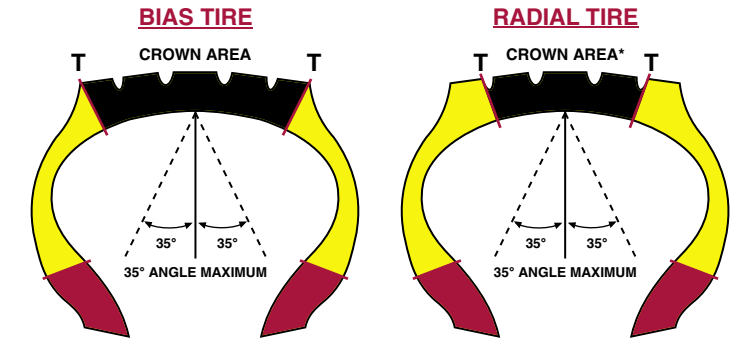

Angles greater than 35° require a 2 piece repair system to be used.

\*Radial tire crown area begins 1" (25mm) from tread edge on passenger tires, or 1½" (40mm) on all truck and ag. tires.

## Radial & Bias Crown Injuries

Prepared Crown Injury Size	H, V, Z Rated & Run Flat Tires (limit 1)	T Rated Tires & Below	Light Truck Tires	Medium & Heavy Truck Tires	Ag, Industrial & Small OTR Tires
3mm	UL3	UL3			
6mm	UL6	UL6	UL6	UL6	
8mm			UL8	UL8	
10mm			UL10	UL10	UL10
13mm			UL13	UL13	UL13

## REPAIRS MUST NOT

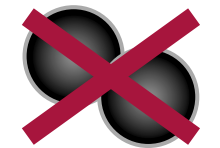

**OVERLAP**

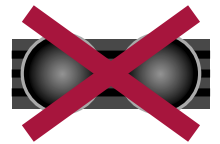

**BE IN THE SAME BODY PLY**

# TECH Bias Skidder Tire Repair Chart

## Prepared Injury Size

PLY RATING (LOAD RANGE)	Inches mm	4" 100	5" 125	6" 150	7" 175	8" 200	9" 225	10" 250	11" 275	12" 300
	10-12	12	12	12	16	16	20	20	24	24
14-16	12	12	16	20	20	20	24	24	24	24
18-20	12	16	20	20	20	24	24	24	TOR9*	TOR9*
22-24	16	20	20	24	24	24	24	TOR9*	TOR9*	TOR9*
26-28	TOR5	TOR6	TOR7	TOR7	TOR8	TOR8	TOR9	TOR9*	TOR9*	TOR10*

FOR 6 TO 8 PLY RATED TIRES AND INJURIES SMALLER THAN SHOWN ON THIS CHART, REFER TO BPT CHART ON PAGE 15. \*CROWN AREA INJURIES ONLY.

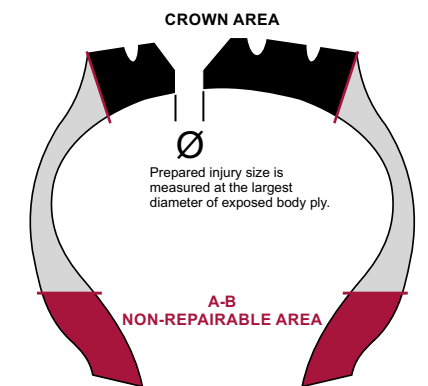

## SKIDDER A-B NON-REPAIRABLE AREA

Section Width	Dimension
14.9-20.8	4", 100mm
23.1 & larger	5", 125mm

# Radial 2-Piece Nail Hole Repair Applications

## Maximum Prepared Injury - Radial

TYPE OF TIRE	Prepared Injury Size	Carbide Cutter	Uni-Seal Stem	Crown Area Repair Unit	Shoulder Area Repair Unit
Passenger Tires (H, V & Z Rated & Run Flat Tires) Limit 1 Per Tire	1/4" (6mm)	CC6 (270)	ULS6 (250-1UL)	CT-10, MP-0 OR 111	
Light Truck Tires	1/4" (6mm)	CC6 (270)	ULS6 (250-1UL)	CT-10, MP-0 OR 111	CT-22
	5/16" (8mm)	CC8 (271)	ULS8 (251-1UL)	CT-12, MP-0 OR 111	CT-22
	3/8" (10mm)	CC10 (271/38)	ULS10 (291-1UL)	CT-20, MP-2 OR 112	CT-24
Truck & Farm Tractor Tires	1/4" (6mm)	CC6 (270)	ULS6 (250-1UL)	CT-10HD, MP-1 OR 111	CT-24
	5/16" (8mm)	CC8 (271)	ULS8 (251-1UL)	CT-12HD, MP-2 OR 111	CT-24
	3/8" (10mm)	CC10 (271/38)	ULS10 (291-1UL)	CT-20 OR 112	CT-26
Heavy Truck & Super Singles	3/8" (10mm)	CC10 (271/38)	ULS10 (291-1UL)	CT-20 OR 112	CT-26

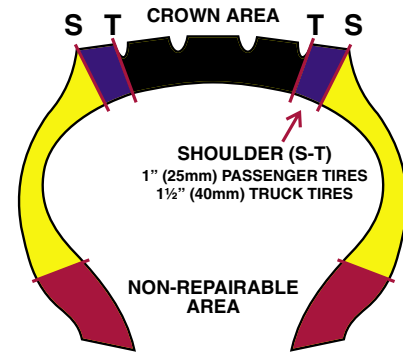

REPAIRS **MUST NOT**

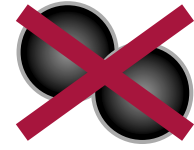

**OVERLAP**

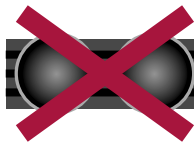

**BE IN THE SAME BODY PLY**

# Bias 2-Piece Nail Hole Repair Applications

## Maximum Prepared Injury - Bias

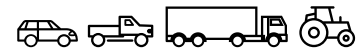

Prepared Injury Size	Carbide Cutter	Uni-Seal Stem	6 Ply	8 Ply	10-12 Ply	14-22 Ply
1/4" (6mm)	CC6 (270)	ULS6 (250-1UL)	MP-0	MP-0	MP-0	MP-1
5/16" (8mm)	CC8 (271)	ULS8 (251-1UL)	MP-0	MP-1	MP-1	MP-1
3/8" (10mm)	CC10 (271/38)	ULS10 (291-1UL)	MP-1	MP-2	MP-2	112

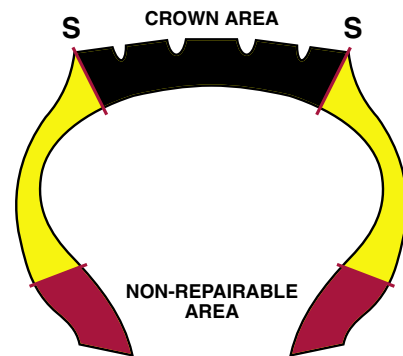

REPAIRS **MUST NOT**

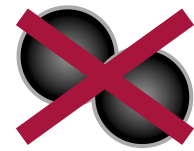

**OVERLAP**

# Centech & Thermacure Radial Repair Chart

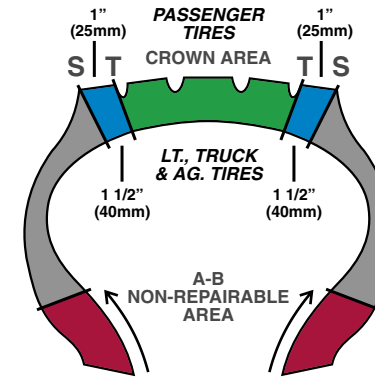

A-B NON-REPAIRABLE AREA	
Passenger Tires	1 1/2" (40mm)
<b>TRUCK TIRE A-B NON REPAIRABLE AREA</b>	
6.50-7.00 (165-195)	2 1/2" (65mm)
7.50-16.00 (205-385)	3" (75mm)
17.5-23.5 (425-600)	3 1/2" (90mm)
<b>AG TIRE A-B NON REPAIRABLE AREA</b>	
13.6-16.9 (345-430)	4" (100mm)
18.4-20.8 (465-530)	4 1/2" (115mm)
23.1 & Larger (585 & larger)	5 1/2" (140mm)

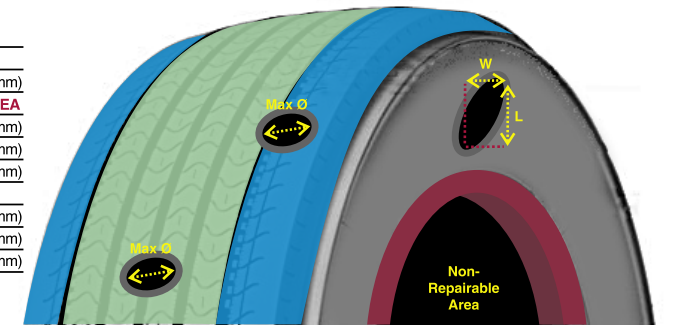

## Centech Radial Passenger Repair Chart

Note: This section repair chart is a guideline only. Local regulations, load and speed can affect the limitations of section repairs. Injuries beyond the crown area and/or larger than 6mm (1/4") after preparation in passenger and some light truck tires should only be repaired in a full service repair facility.

CROWN AREA BEGINS 1" (25mm) IN FROM TREAD EDGE

Sidewall Injury	Crown Injury Diameter	Through U Speed Rating	Speed Rated H, V, W, Y & Z, and Run Flat Tires
1/4" (6mm)	1/2" (13mm)	10	10
1/4" (6mm)	2" (50mm)	12	
3/8" (10mm)	3/8" (10mm)	10HD	
3/8" (10mm)	1 1/2" (40mm)	12HD	
3/8" (10mm)	2" (50mm)	14	
1/2" (13mm)	1 1/2" (40mm)	12HD	
1/2" (13mm)	2" (50mm)	14	
3/4" (20mm)	3/4" (20mm)	12HD	
3/4" (20mm)	1 1/2" (40mm)	12HD	
3/4" (20mm)	2" (50mm)	14	
1" (25mm)	1 1/2" (40mm)	14	
1" (25mm)	2" (50mm)	14	

TO MAINTAIN THEIR SPEED RATING, PASSENGER TIRES CARRYING A SPEED RATING OF H, V, W, Y OR Z SHOULD ONLY BE REPAIRED IN THE CROWN (T-T) AREA WITH A MAXIMUM SIZE OF 1/4" (6mm).

## Centech Radial AG Tire Repair Chart

CROWN AREA BEGINS 1 1/2" (40mm) IN FROM TREAD EDGE

Sidewall Injury	Shoulder Injury	Crown Injury Diameter	Tractor Sizes		
			8-11 8.3-12.4	12-15 13.6-23.5 440/65-600/65	24.5-30.5 620/75-1050/50
1/4" (6mm)	1/4" (6mm)	3/8" (10mm)	12	12	20
3/8" (10mm)	3/8" (10mm)		12	12	20
3/8" (10mm)	1 1/2" (40mm)		20	20	22
3/8" (10mm)	5" (125mm)		26	26	26
	3/8" (10mm)		20	20	22
3/4" (20mm)	3/4" (20mm)	3/4" (20mm)	20	20	22
3/4" (20mm)	3" (75mm)		22	80	80
	3/4" (20mm)		22	80	80
1 1/2" (40mm)	4" (100mm)	1 1/2" (40mm)	80	82	82
	1 1/2" (40mm)		80	82	82
2" (50mm)	3 1/4" (80mm)	2 3/4" (70mm)	80	82	84
	2" (50mm)		82	84	84
2 1/2" (65mm)	3" (75mm)		80	82	84
2 1/2" (65mm)	4" (100mm)		80	82	84
2 3/4" (70mm)	2 3/4" (70mm)		80	82	84
	2 3/4" (70mm)		86	86	86
3 1/4" (80mm)	3 1/4" (80mm)	3 1/2" (90mm)	84	86	86
3 1/4" (80mm)	5 1/4" (130mm)		84	86	86
	3 1/2" (90mm)		88	90	90
3 1/2" (90mm)	4 1/2" (115mm)		84	86	86
3 1/2" (90mm)	7 1/8" (180mm)		84	86	86
4" (100mm)	4" (100mm)		84	86	86
4" (100mm)	6 1/2" (165mm)		86	88	88
4" (100mm)	8" (200mm)		88	88	88
5" (125mm)	5" (125mm)		86	88	88
5" (125mm)	10" (250mm)		86	88	88
5 1/2" (140mm)	6" (150mm)		88	90	90
6" (150mm)	8" (200mm)		88	90	90

NOTE: THIS SECTION REPAIR CHART IS A GUIDELINE ONLY. LOAD, SPEED AND HIGHWAY APPLICATION CAN AFFECT THE LIMITATIONS OF SECTION REPAIRS.

## Centech Radial Truck Tire Repair Chart

CROWN AREA BEGINS 1 1/2" (40mm) IN FROM TREAD EDGE

Sidewall Injury	Shoulder Injury Diameter (S-T Area)	Crown Injury Diameter (T-T Area)	Truck Tire Sizes		
			Light Truck Through Load Range E 6.50-12.50 LT 215-285	7.50-10.00 235/80-275/80 225/75-295/75	Heavy Truck 11.00-14.00 12-16.5 295/80-315/80 305/75-445/65 425/50-495/45
Width	Length				
1/4" (6mm)	1/4" (6mm)	1/4" (6mm)	10 or 111	10HD or 111	10HD or 111
			10	20	20
		1/4" (6mm)	22	24	26
		5/16" (8mm)	12 or 111	12HD or 111	12HD or 111
5/16" (8mm)	5/16" (8mm)		12	20	20
		5/16" (8mm)	22	24	26
		3/8" (10mm)	20 or 112	20 or 112	20 or 112
1 Cable	1 1/2" (40mm)		20	20	20
1 Cable	3 1/8" (80mm)		22	24	24
1 Cable	4 3/4" (120mm)		24	24	24
1 Cable	6" (150mm)		26	26	26
2 Cables	3/4" (20mm)		20	20	24
2 Cables	1 1/2" (40mm)		20	24	24
2 Cables	2 3/8" (60mm)		22	24	26
2 Cables	5 1/8" (130mm)		22	26	26
3/8" (10mm)	1 1/2" (40mm)		20	26	40
3/8" (10mm)	2 3/8" (60mm)		22	26	40
3/8" (10mm)	3 1/8" (80mm)		26	40	42
3/8" (10mm)	5 1/8" (130mm)		26	42	44
	3/8" (10mm)		24	26	26
	1/2" (13mm)	1/2" (13mm)	22	33 or 40	33 or 40
1/2" (13mm)	1 1/2" (40mm)		22	40	40
1/2" (13mm)	2 3/4" (70mm)		22	40	42
1/2" (13mm)	3 3/4" (95mm)		40	42	42
1/2" (13mm)	5 1/8" (130mm)		40	44	44
	1/2" (13mm)		40	40	40
	3/4" (20mm)		22	33 or 40	35 or 42
3/4" (20mm)	1" (25mm)		22	40	40
3/4" (20mm)	2 1/2" (65mm)		24	42	42
3/4" (20mm)	4 3/8" (110mm)		44	42	44
3/4" (20mm)	5 1/8" (130mm)		44	44	44
	3/4" (20mm)		40	42	42
1" (25mm)	2" (50mm)	1" (25mm)	33 or 40	35 or 42	37 or 44
1" (25mm)	3 1/4" (80mm)		40	42	44
1" (25mm)	4" (100mm)		44	44	44
	1" (25mm)		44	44	44
1 1/4" (32mm)	2" (50mm)	1 1/4" (32mm)	35 or 42	37 or 44	44
1 1/4" (32mm)	3 1/8" (80mm)		42	44	44
1 1/4" (32mm)	4" (100mm)		44	44	44

NOTE: THIS SECTION REPAIR CHART IS A GUIDELINE ONLY. LOAD, SPEED AND HIGHWAY APPLICATION CAN AFFECT THE LIMITATIONS OF SECTION REPAIRS.

Repair Unit	REPAIR UNIT DIMENSIONS	
	Inches	Millimeters
CT10	1.75 X 3	45 X 75
CT10HD	2.5 X 3.25	65 X 80
CT12	2.38 X 4.38	60 X 110
CT12HD	2.75 X 4.6	70 X 115
CT20	3 X 5	75 X 125
CT22	3 X 6.5	75 X 165
CT24	3 X 8.5	75 X 215
CT26	3 X 10	75 X 250
CT33	4 X 5	100 X 125
CT35	5 X 6	125 X 150
CT37	5 X 6.75	125 X 170
CT40	4 X 8	100 X 200
CT42	5 X 10	125 X 250
CT44	5 X 13	125 X 330
CT46	5.5 X 16	140 X 405

REPAIR UNITS SHOWN **BOXED IN GREEN** ARE LIMITED TO THE CROWN (T-T) AREA ONLY.



# BP Bias Repair Chart



**A-B NON-REPAIRABLE AREA**

7.00-8.75	3 1/4", 80mm
9.00-14.00	4", 100mm
16.00-18.00	5", 125mm
21.00-27.00	6", 150mm

The above dimensions are guidelines only.

**TRACTOR A-B NON-REPAIRABLE AREA**

Section Width	A-B Dimension
14.9-20.8 (215-520)	4", 100mm
23.1 & Larger (600 & Larger)	5", 125mm

The above dimensions are guidelines only.

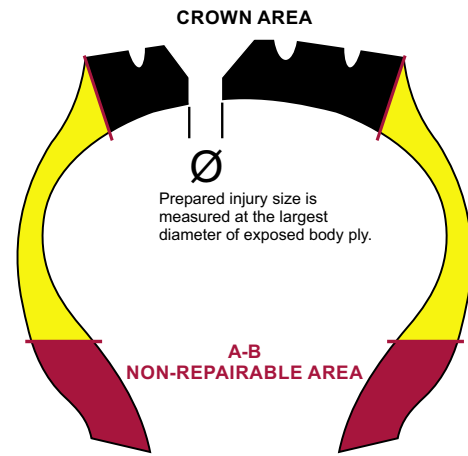

**CHART INSTRUCTIONS:** For proper repair unit selection, determine the size of the injury in the tire by measuring largest cord area removed. Locate the correct injury size along the top row of the chart. Now locate the tire's ply rating (load range) along the left column of the same chart. The repair unit number shown in the box where these intersect is the correct repair unit to use.

NOTE: THIS SECTION REPAIR CHART IS ONLY A GUIDELINE. LOAD, SPEED AND APPLICATION OF THE TIRE CAN AFFECT THE LIMITATIONS OF SECTION REPAIRS.

**CAR, TRUCK AND EARTHMOVER  
SIZE OF INJURY - TREAD, SHOULDER AND SIDEWALL**

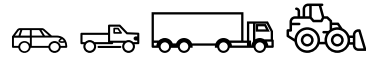

PLY RATING (LOAD RANGE)	mm inches	SIZE OF INJURY - TREAD, SHOULDER AND SIDEWALL												
		3 1/8"	6 1/4"	10 3/8"	13 1/2"	20 3/4"	25 1"	40 1 1/2"	50 2"	65 2 1/2"	75 3"	100 4"	125 5"	150 6"
4 (B)	MP-0	MP-0	MP-1	MP-2	BP-3	BP-3	BP-4	BP-5						
6 (C)	MP-0	MP-0	MP-1	MP-2	BP-3	BP-3	BP-4	BP-5	BP-6					
8 (D)	MP-0	MP-0	MP-2	BP-3	BP-3	BP-4	BP-4	BP-5	BP-6					
10 (E)	MP-0	MP-1	MP-2	BP-3	BP-3	BP-4	BP-5	BP-6	BP-6	BP-7	BP-8			
12 (F)	MP-0	MP-1	MP-2	BP-4	BP-4	BP-4	BP-5	BP-6	BP-6	BP-7	BP-8			
14 (G)	MP-0	MP-1	BP-3	BP-4	BP-4	BP-4	BP-5	BP-6	BP-6	BP-7	BP-8	BP-10		
16 (H)	MP-0	MP-1	BP-4	BP-4	BP-5	BP-5	BP-6	BP-6	BP-7	BP-7	BP-8	BP-10		
18 (J)	MP-0	MP-1	BP-4	BP-5	BP-5	BP-6	BP-6	BP-7	BP-8	BP-8	BP-9	BP-10		
20 (L)	MP-0	MP-1	BP-4	BP-5	BP-5	BP-6	BP-7	BP-8	BP-8	BP-9	BP-9	BP-10		
22 (M)	MP-0	MP-1	BP-4	BP-6	BP-6	BP-7	BP-8	BP-8	BP-9	BP-9	BP-10			

**FARM, TRACTOR, SKIDDER  
SIZE OF INJURY - TREAD, SHOULDER AND SIDEWALL**



PLY RATING (LOAD RANGE)	mm inches	SIZE OF INJURY - TREAD, SHOULDER AND SIDEWALL																
		3 1/8"	6 1/4"	10 3/8"	13 1/2"	20 3/4"	25 1"	40 1 1/2"	50 2"	65 2 1/2"	75 3"	100 4"	125 5"	150 6"	175 7"	200 8"	225 9"	250 10"
4 (B)	MP-0	MP-0	MP-1	MP-2	BP-3	BP-3	BP-4	BP-5	BPT-0	BPT-0	BPT-1	BPT-2	BPT-2	BPT-3	BPT-3			
6 (C)	MP-0	MP-0	MP-1	MP-2	BP-3	BP-3	BP-4	BP-5	BPT-0	BPT-0	BPT-1	BPT-2	BPT-2	BPT-3	BPT-3			
8 (D)	MP-0	MP-1	MP-2	MP-2	BP-3	BP-4	BP-4	BP-5	BPT-0	BPT-0	BPT-1	BPT-2	BPT-2	BPT-3	BPT-3	BPT-6	BPT-7	
10 (E)	MP-0	MP-1	MP-2	BP-3	BP-3	BP-4	BP-5	BP-6	BPT-1	BPT-1	BPT-4	BPT-5	BPT-5	BPT-6	BPT-6	BPT-7	BPT-7	
12 (F)	MP-0	MP-1	MP-2	BP-4	BP-4	BP-4	BP-5	BP-6	BPT-4	BPT-4	BPT-4	BPT-5	BPT-5	BPT-6	BPT-7	BPT-7	BPT-7	
14 (G)	MP-0	MP-1	BP-4	BP-4	BP-4	BP-5	BP-6	BP-6	BPT-4	BPT-5	BPT-5	BPT-5	BPT-6	BPT-7	BPT-7	BPT-7	*	
16 (H)	MP-0	MP-1	BP-4	BP-4	BP-5	BP-5	BP-6	BP-6	BPT-5	BPT-5	BPT-5	BPT-6	BPT-6	BPT-7	*	*	*	
18 (J)	MP-1	MP-2	BP-4	BP-5	BP-5	BP-6	BP-7	BPT-5	BPT-5	BPT-6	BPT-6	BPT-7	*	*	*	*	*	

\* FOR INJURIES LARGER THAN INDICATED ON THIS CHART OR FOR TIRES WITH PLY RATINGS HIGHER THAN 18, REFER TO THE BIAS SKIDDER REPAIR CHART.

**\*REINFORCEMENT REPAIRS  
SIZE OF INJURY - TREAD, SHOULDER AND SIDEWALL**



PLY RATING (LOAD RANGE)	mm inches	SIZE OF INJURY - TREAD, SHOULDER AND SIDEWALL											
		6 1/4"	10 3/8"	13 1/2"	20 3/4"	25 1"	40 1 1/2"	50 2"	65 2 1/2"	75 3"	100 4"	125 5"	150 6"
8-12 (D-F)	MP-0	MP-1	MP-2	BP-3	BP-3	BP-4	BP-4	BP-5	BP-6	BP-7	BP-8		
14-18 (G-J)	MP-0	MP-1	MP-2	BP-4	BP-4	BP-5	BP-5	BP-6	BP-6	BP-7	BP-8		
20-22 (L-N)	MP-0	MP-2	BP-4	BP-5	BP-5	BP-6	BP-6	BP-7	BP-7	BP-8	BP-9		

\* INJURIES THROUGH 25%, BUT LESS THAN 75% OF THE BODY PLYS REQUIRE BOTH HOLE FILLING MATERIAL AND REINFORCED REPAIR UNIT TO BE INSTALLED INSIDE THE TIRE.

# AX Aramid Reinforced Radial OTR Repair Chart Severe Service Repairs

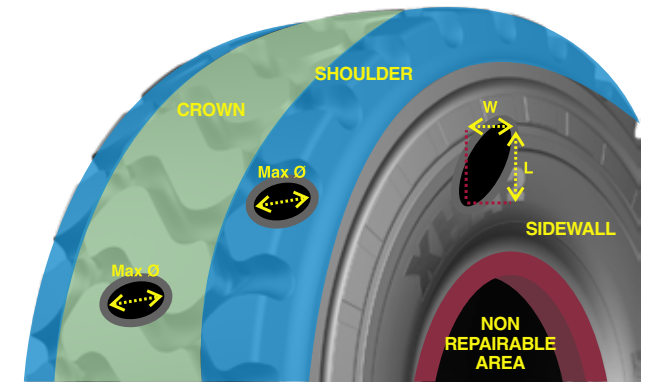

Sidewall Injury	Shoulder Injury	Crown Injury	Earthmover Tire Sizes				
			Inner liner removed on all severe service applications				
Width inches (mm)	Length inches (mm)	Diameter inches (mm)	Diameter inches (mm)	18.00-21.00 20.5-26.5	24.00-27.00 29.5-33.5 35/65	30.00-33.00 37.25-37.50 40/65-45/65	36.00-40.00 46/90-59/80 50/65-65/65
1 (25)	10 (250)		1 (25)	CT45A	CT45A	CT45A	CT45A
1 1/4 (30mm)	12 (300)		1 (25)	AX50	AX60	AX80	AX100
1 1/2 (40)	14 (350)		1 1/2 (40)	AX50	AX60	AX80	AX100
1 1/2 (40)	16 (400)		1 1/2 (40)	AX80	AX100	AX100	AX120
2 (50)	8 (200)		2 (50)	CT55A	CT55A	CT55A	CT55A
2 (50)	11 (275)			AX50	AX80	AX100	AX120
2 (50)	14 (350)			AX60	AX80	AX100	AX120
2 (50)	18 (450)				AX80	AX120	AX140
2 (50)	19 (475)				AX120	AX140	AX140
2 (50)	22 1/2 (570)		2 (50)	AX50	AX80	AX120	AX140 OR AX155*
2 3/8 (60)	18 (450)					AX140	AX155
2 1/2 (65)	6 (150)		2 1/2 (65)	CT55A	CT65A	CT65A	CT65A
2 1/2 (65)	14 (350)			AX50	AX80	AX100	AX140
2 3/4 (70)	16 (405)				AX100	AX120	AX155
3 (75)	5 1/2 (140)		3 (75)		CT65A	CT75A	CT75A
3 (75)	11 (275)			AX50	AX80	AX100	AX140
3 (75)	12 (300)			AX100	AX120	AX120	AX140
3 (75)	16 (400)			AX120	AX120	AX120	AX155
3 1/4 (85)	16 1/2 (420)		3 (75)	AX60	AX100	AX140	AX140 OR AX155*
3 1/2 (90)	7 1/2 (190)		3 1/2 (90)		CT75A	CT75A	CT75A
3 1/2 (90)	9 (225)			AX60	AX80	AX120	AX120
3 1/2 (90)	12 (300)			AX80	AX100	AX120	AX140
4 (100)	5 (125)		4 (100)		CT75A	CT75A	CT75A
4 (100)	6 (150)			AX60	AX100	AX120	AX140
4 (100)	9 (225)			AX100	AX100	AX120	AX140
4 (100)	11 (275)			AX100	AX120	AX140	AX155
4 1/2 (115)	6 1/2 (165)		4 (100)		AX120	AX140	AX155
4 3/4 (120)	6 (150)			AX80	AX120	AX120	AX140
4 3/4 (120)	10 1/2 (265)				AX140	AX140	AX140
5 (125)	5 (125)		5 (125)		CT85A	CT85A	CT85A
5 (125)	7 (175)				AX120	AX120	AX140
					AX120	AX120	AX140
6 (150)	3 (75)		5 1/2 (140)		CT85A	CT85A	CT85A
6 (150)	5 (125)				AX120	AX140	AX140

\*USE THE AX140 ON 57" TIRES AND THE AX155 ON 63" TIRES.

REPAIR UNITS SHOWN [BOXED IN GREEN] ARE LIMITED TO CROWN (T-T) AREA ONLY. NOTE: THIS SECTION REPAIR CHART IS A GUIDELINE ONLY.

**RADIAL/OTR NON-REPAIRABLE AREA**

14.00-16.00 (15.5-17.5)	3", 75mm
18.00-24.00 (20.5-29.5)	5", 125mm
27.00-33.00 (33.25-37.5)	6", 150mm
40/65-50/65 (40.5)	6 3/4", 170mm
36.00	8", 200mm
37.00-40.00 (50.5 & larger)	10", 255mm

**DETERMINING CROWN INJURY REPAIR AREA (T-T AREA)**

**Radial/OTR Crown Dimensions (T-T Area)**  
Crown is defined as 50% of tread face for standard aspect ratio tires and 60% of tread face for wide base sizes. All measurements are taken on the outside surface of the tire.

**Standard Aspect Tire Size Example (24.00 R35):**  
If the tread face measures 24" (610mm) wide, 50% of that is 12" (300mm) - the crown area measurement, or 6" (150mm) on each side of the tread centerline. This is where the injury must be located to be considered as a crown area repair.

**Wide Base Tire Size Example (29.5 R29):**  
If the tread face measures 25" (635mm) wide, 60% of that is 15" (375mm) - the crown area measurement, or 7.5" (190mm) on each side of the tread centerline. This is where the injury must be located to be considered as a crown area repair.

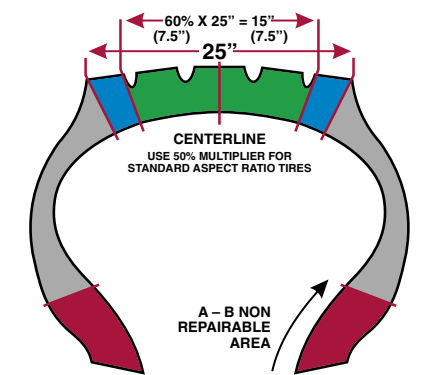

Repair Unit	REPAIR UNIT DIMENSIONS	
	inches	mm
CT45A	9 1/8 X 7 3/4	230 X 195
CT55A	13 X 10 1/4	330 X 260
CT65A	16 1/2 X 13	420 X 330
CT75A	20 3/4 X 17 X 3/4	535 X 450
CT85A	28 X 22	710 X 560
AX50	5 1/2 x 20 1/2	140 x 520
AX60	8 1/2 x 24	215 x 610
AX80	9 1/2 x 28	240 x 710
AX100	11 x 31	280 x 790
AX120	11 x 35	280 x 890
AX140	14 1/2 x 47	370 x 1190
AX155	10 x 55	250 x 1400





# Monaflex OTR Vulcanizing System Radial/Bias Ply Application Chart

TIRE RANGE: OTR 13.00 TO 55.5/85-63 TRACTOR / OTR & WIDE BASE

CONTROL PANEL			M100				
Tractor/Wide Base	Tire Section	Cylinder Bag	Inside Flat Bag	Inside Heat Pad		Outside Heat Pad	External Pack With Flat Bag & Straps
				Bias	Radial		
14.4-24 to 16.9-38	13.00 to 17.5	TR1315/20W		MX2519H	MX3015H	TRX2621H	TR2621E with TROC5XL Straps
18.4-34 to 20.8-42	18.00 to 21.00	M1721/24W		MX2519H OR MX2626H	MX3015H	TRX2621H	TR2621E with TROC5XL Straps
23.1-26 to 30.5-32	23.5 to 26.5	M1721/24W	M4824W	MX2519H OR MX2626H	MX3015H	TRX2621H	TR2621E with TROC5XL Straps
25/65-25	27.00 to 29.5	M1721/24W	M4824W M5432W	MX2519H OR MX2626H	MX3015H OR MX4220H	TRX2621H	TR2621E with TROC5XL Straps
35/65-33 to 45/65-45	30.00 to 37.5	M2732/32W	M5432W	MX3132H OR MX2626H	MX4220H OR MX4224H	MX2626H OR MX3132H	M4832E with M45/6/7 (1HG) 6 Straps
49.5/85-57 to 50/65-51	40.00	M3842/32W		MX3132H OR MX2626H	MX4220H OR MX4224H OR MX4824H OR MX5224H	MX2626H OR MX3132H	M4832E with M45/6/7 (1HG) 6 Straps
		M3842/32W	M5432W				
50/80-57 to 55/80-57		M4447/32W		MX3132H OR MX2626H	MX4220H OR MX4224H OR MX4824H OR MX5224H	MX2626H OR MX3132H	M4832E with M45/6/7 (1HG) 6 Straps
53.5/85-57 53.5/85-63 55.5/80-57 55.5/85-57 55.5/85-63		M4447/32W	M7532W OR M9032W	MX3132H OR MX2626H	MX4220H OR MX4224H OR MX4824H OR MX5224H	MX2626H OR MX3132H	M4832E with M45/6/7 (1HG) 6 Straps
60/60-57 70/70-57 80/70-57		M5054/32W	M9032W	MX3132H OR MX2626H	MX4220H OR MX4224H OR MX4824H OR MX5224H	MX2626H OR MX3132H	M4832E with M45/6/7 (1HG) 6 Straps

# Product Index

Item Number	Page		
208.....	25	607.....	14
2PC.....	126	607R.....	15
09.....	20	608.....	14
10.....	20	608R.....	15
10T.....	20	609.....	14
11.....	20	609R.....	15
11T.....	20	610.....	14
12.....	20	620.....	14
12T.....	20	621.....	14
13.....	20	622.....	14
13T.....	20	623.....	14
14.....	20	624.....	14
15.....	20	625.....	14
16.....	20	626.....	14
17.....	20	627.....	14
18.....	20	672.....	21
19.....	20	704.....	31
20.....	20	704-55G.....	31
111.....	21	704-5G.....	31
111R.....	13	704A.....	31
112R.....	13	704G.....	31
115.....	21	705C.....	31
116.....	21	705C-5G.....	31
164.....	11	706-1.....	31
164R.....	13	720.....	30
165.....	11	720-55G.....	30
165T.....	11	720-5G.....	30
166.....	11	721.....	30
166R.....	13	722.....	30
167.....	11	723.....	30
167T.....	11	730.....	101
169.....	11	730C.....	101
170.....	11	731.....	101
170R.....	13	732.....	101
172.....	11	732C.....	101
172R.....	13	734.....	30
174.....	11	734-55G.....	30
174R.....	13	734-5G.....	30
176.....	12	734Q.....	30
177.....	12	735.....	30
177R.....	13	738.....	31
178.....	12	738G.....	31
178R.....	13	739.....	31
179.....	12	743.....	101
179R.....	13	743SP.....	101
180.....	12	751.....	31
180R.....	13	751-55G.....	31
182.....	12	751-5G.....	31
182R.....	13	753.....	31
184.....	12	760.....	32
184R.....	13	761.....	32
196.....	12	762.....	32
197.....	12	765.....	32
198.....	12	766.....	32
199.....	12	767.....	32
204.....	25	768.....	32
206.....	25	770.....	32
208.....	25	772.....	32
209.....	25	775.....	32
211.....	25	776.....	32
212.....	25	777.....	32
215PK.....	24	783.....	30
216TK.....	24	783-SE.....	30
217.....	25	784.....	30
220.....	24	784LP.....	30
221-675-2.....	90	848BX.....	23
221-675-2-B.....	90	849BX.....	22
222.....	24	850BX.....	22
224.....	24	854BX.....	23
226.....	24	855BX.....	22
249UL.....	8	857A.....	23
250-1UL.....	9	857B.....	23
250UL.....	8	858.....	23
250UL/24.....	8	859.....	23
251UL/24.....	8	861BX.....	22
251-1UL.....	9	862BX.....	22
251UL.....	8	863BX.....	22
252.....	9	864BX.....	22
252-1.....	10	865BX.....	22
253.....	9	866BX.....	22
253-1.....	10	867BX.....	22
254-1.....	10	868BX.....	22
269.....	39	869BX.....	22
270.....	39	870BX.....	22
270P.....	39	900.....	36
271.....	39	903.....	36
271/38.....	39	905.....	36
271P.....	39	910.....	36
272.....	39	913.....	38
273.....	39	915.....	36
280.....	39	916.....	36
282.....	39	918.....	36
283.....	39	919.....	36
284.....	39	920.....	36
284C.....	39	921.....	36
286.....	39	922.....	36
290UL.....	8	923.....	36
291-1UL.....	9	925.....	36
291UL.....	8	925E.....	36
292UL.....	8	925T.....	36
418-08907.....	31	926.....	36
418-08910.....	31	927.....	36
600.....	10	928B.....	36
600T.....	10	931.....	38
601.....	10	931.....	69
602.....	10	933.....	36
603.....	14	935.....	36
603R.....	15	936.....	36
604.....	14	938.....	36
604R.....	15	939.....	36
605.....	14	940.....	37
605R.....	15	941.....	37
606.....	14	942.....	37
606R.....	15	946W.....	37
		946Y.....	37

## Product Index

947W	37	8184432	90	CM031	61	ESCO10200	71
947Y	37	8314813	91	CM27T	87	ESCO10202	71
948	37	8314813	91	CP871	46	ESCO10207	71
948Y	37	14024784	91	CP871K	46	ESCO10209	71
949	37	20011064	92	CP873	46	ESCO10300	71
950	37	20024335	91	CP873K	46	ESCO30120	70
950W	37	24016079	92	CP9288	46	ESCO30125	70
951	37	82008402	91	CT	126	ESCO40100	69
951Y	37	83008403	91	CT45AC	17	ESCO40107	69
963	30	89209611	92	CT45AH	17	ESCO50100	70
964	30	AC-1431	48	CT45AR	17	ESCO50303	70
968LB	32	AC-1431-2	48	CT46AC	16	ESCO60100	70
968RLB	32	AC-1777	48	CT46AR	13	ESCO60101	70
971	30	AC-1991	48	CT46AR	16	ESCO60102	70
973	38	AC-1992	48	CT50AC	16	ESCO60104	70
975	31	AC-1994	48	CT50AR	16	ESCO60105	70
976	123	AC-6400	46	CT52AC	16	ESCO60300	69
977	123	AC-6403	46	CT52AR	16	ESCO60301	69
978	123	AH440	62	CT55AC	16	EZ1	83
982	100	AME11010	72	CT55AC	17	EZ29	82
990	70	AME11030	72	CT55AH	17	EZ9	82
1082	32	AME13000	72	CT55AR	17	FHIFVE210B	114
1082-55G	32	AME14465	72	CT56AC	16	FHIVFE250B	114
1082-5G	32	AME15000	72	CT56AR	16	G12100	74
1082G	32	AME15002	72	CT60AC	16	G12894-C	75
1181	125	AME15230	72	CT60AR	16	G12894P	75
1182	125	AME15260	72	CT62AC	16	G2008401	91
1183	125	AMF855	62	CT62AR	16	G3008403	91
1184	125	AX100C	18	CT65AC	17	G432003	79
1185	125	AX100U	18	CT65AH	17	G471105HD	79
1186	125	AX120C	18	CT65AR	17	GAI12880	75
1187	125	AX120U	18	CT72AC	16	GAI12894-CW	75
1188	125	AX140C	18	CT72AR	16	GAI12894-CW	75
1612	38	AX140U	18	CT75AC	17	GAI451205	79
6213	21	AX155C	18	CT75AH	17	GAIG12100-1	74
6214	21	AX50C	18	CT75AR	17	GAIG450301	79
6218	21	AX50U	18	CT85AC	17	GAIG451600	79
6230	21	AX60C	18	CT85AH	17	GAIGB-5M	78
24335	91	AX60U	18	CT85AR	17	GAIGB-5Z	78
24335	91	AX80C	18	CTOR	126	GAIGT-3531	79
24335	91	AX80U	18	DWA1000XL	88	GAIGTABB-01	77
96010	37	BN18	23	DWA1000XLB	89	GAIGTO-01TB	79
250309	91	BP	126	DWA1000XLT	89	GB-5ZA	78
254341A	92	BRA5120	100	DWA4000	88	GBB6LM	78
450310	91	BRA5500	100	E10100	71	GBB9LM	78
2200981	91	BT18	23	E10101	71	GH100BX	23
2200981	91	BTLG-12510#BX	23	E10312	71	GH200X	23
3008403	91	C202SE	83	E70150	72	GH218BX	23
4024784	91	C206	84	E70160	71	GTS-01	100
5150524	90	C212	84	EAA0247G15A	93	HAL5131	121
8113125C	93	C218	84	EAA0247G20A	91	HAL753S-XXX	116
8182788	92	C3FR250F	58	ER100	80	HALG-170S	113
8182960	90	C4D600F	58	ER71	82	HALGA-1555-RCL	61
8182961	92	C4D600F36H	58	ER72TD	81	HALGA-240	60
8182963	92	C5D600F	58	ER73TD	81	HALGA-255	60
8183061	90	C5D600F36H	58	ER75TD	81	HALIN-20	121
8183604	93	CM030	61	ESCO10102	71	HALIN-80A	117

## Product Index

HALLR-25	119	JS60300	78	JS79279	53	JS79344	54
HALLR-29	119	JS78243	50	JS79279	54	JS79345	54
HALLR-33	119	JS78530	50	JS79281	53	JS79346	54
HALLR-35	119	JS78538	57	JS79282	53	JS79347	54
HALM-1900-8	117	JS78539	57	JS79283	53	JS79348	54
HALM-1950-8	117	JS78540	57	JS79284	53	JS79349	54
HALMT-3000	117	JS78541	57	JS79286	54	JS79351	56
HALN-1410	121	JS78542	57	JS79288	55	JS79352	56
HALNI-106	63	JS78543	57	JS79289	55	JS79353	56
HALOR-215-H	119	JS78544	57	JS79290	55	JS79354	56
HALPT-300-J-650	118	JS78545	57	JS79291	55	JS79355	56
HALPT-EX	118	JS78546	57	JS79292	55	JS79356	56
HALPT-GAUGE	118	JS78547	57	JS79293	55	JS79357	56
HALR-520	117	JS78548	57	JS79294	55	JS79359	52
HALR-525	117	JS78549	57	JS79296	55	JS79362	52
HALR-660	117	JS78550	57	JS79296	56	JS79363	50
HALR-760-100	118	JS78551	57	JS79297	55	JS79364	50
HALR-760-50	118	JS78552	57	JS79298	55	JS79365	50
HALR-969-K	118	JS78553	57	JS79299	55	JS79375	50
HALR-969K-1	118	JS79238	53	JS79300	55	JS79375	52
HALSBHAT	118	JS79238	54	JS79301	55	JS79376	50
HALT-620	118	JS79239	53	JS79302	55	JS79376	52
HALT-81	117	JS79240	53	JS79303	55	JS79377	50
HALT-82	117	JS79241	53	JS79304	55	JS79377	52
HALWHG-8018VC	116	JS79242	53	JS79306	55	JS79378	50
HALWHG-8019VC	116	JS79243	53	JS79307	55	JS79378	52
HAM-D045	107	JS79244	53	JS79308	55	JS79403	51
HI401	109	JS79245	53	JS79309	55	JS79404	51
HN8	38	JS79247	52	JS79310	55	JS79405	51
HUNTER TCX	92	JS79248	52	JS79311	55	JS79406	51
IM-10005	125	JS79249	52	JS79312	55	JS79407	51
J1	74	JS79250	52	JS79313	55	JS79408	51
JS301150	51	JS79251	52	JS79314	55	JS95615-01	57
JS301160	51	JS79252	52	JS79316	52	JS95615-02	57
JS60099	69	JS79253	52	JS79317	52	JS95615-03	57
JS60143	50	JS79254	52	JS79318	52	JS95615-04	57
JS60144	50	JS79256	53	JS79319	52	JS95615-05	57
JS60145	50	JS79257	53	JS79321	56	JS95632	57
JS60156	59	JS79258	53	JS79322	56	JS95845	50
JS60157	59	JS79259	53	JS79323	56	JS97025	51
JS60158	59	JS79260	53	JS79324	56	JS97025	52
JS60159	59	JS79261	53	JS79325	56	JS97911	69
JS60160	59	JS79262	53	JS79327	54	JS99440	50
JS60161	59	JS79263	53	JS79328	54	JS99440	51
JS60162	59	JS79265	54	JS79329	54	JS99471	69
JS60163	59	JS79266	54	JS79330	54	JS99560	51
JS60164	59	JS79267	54	JS79331	54	JS99561	51
JS60165	59	JS79268	54	JS79333	56	JS99562	51
JS60166	59	JS79269	54	JS79334	56	JS99563	51
JS60187	51	JS79270	54	JS79335	56	JS99766	51
JS60187	52	JS79271	54	JS79336	56	JS99767	51
JS60228	51	JS79272	54	JS79337	56	JS99768	51
JS60229	51	JS79272	54	JS79338	56	JS99769	51
JS60230	51	JS79274	52	JS79339	56	JS99770	51
JS60230	52	JS79275	52	JS79340	56	JS99771	51
JS60231	51	JS79276	52	JS79341	56	JS99772	51
JS60231	52	JS79277	52	JS79343	54	JS99773	51



## Product Index

JS99774.....	51	KEN34849.....	72	MONM4824W.....	65	PEQS2000.....	124
JS99775.....	51	KEN34950.....	74	MONM5432W.....	65	PEQS3000.....	124
K22.....	83	KEN35104.....	76	MONM6732W.....	65	PESK2000.....	124
KEN30165.....	76	KEN35105.....	76	MONM7532W.....	65	PESK3000.....	124
KEN30515.....	69	KEN35129.....	75	MONMVS9000/615.....	64	PESSG060N.....	124
KEN30606.....	70	KEN35229.....	75	MONMVS9000/616.....	64	PESSG7500N.....	124
KEN30609.....	76	KEN35321.....	76	MONMX1616H.....	64	PESSM600N.....	124
KEN30610.....	76	KEN353223.....	76	MONMX2519H.....	64	PESST300N.....	124
KEN30612.....	76	KEN35325.....	76	MONMX2626H.....	64	PESST32000N.....	124
KEN30618.....	76	KEN35327.....	75	MONMX3015H.....	64	PS-1.....	100
KEN30618.....	76	KEN35329.....	75	MONMX3026H.....	64	PTC.....	126
KEN30619.....	76	KEN35421.....	76	MONMX3132H.....	64	RAH1225.....	62
KEN30620.....	76	KEN35423.....	76	MONMX4215H.....	64	RAH1250.....	62
KEN30620.....	76	KEN35425.....	76	MONMX4220H.....	64	RAH3825.....	62
KEN31551.....	100	KEN35427.....	75	MONMX4224H.....	64	RAH3850.....	62
KEN31554.....	100	KEN35429.....	75	MONMX4824H.....	64	RAH38700.....	62
KEN31568.....	76	KEN35440.....	73	MONO2517.....	65	RDVD1.....	126
KEN31710.....	73	KEN35449.....	72	MONOS2117.....	65	RH100.....	40
KEN31810.....	73	KEN35595.....	77	MONOSH2215.....	65	RH100GEG-134-80.....	42
KEN32101.....	73	KEN35620.....	77	MONOSH2815.....	65	RH100GEG-138-80.....	42
KEN32102.....	73	KEN35630.....	77	MONTR1315/20W.....	64	RH100GEG-200-80.....	42
KEN32106.....	73	KEN35656.....	77	MONTRRS.....	64	RH102.....	40
KEN32109.....	73	KEN35657.....	77	MONTRX2213H.....	64	RH104.....	40
KEN32116.....	73	KEN35659.....	77	MONTRX2621H.....	64	RH107.....	40
KEN32119.....	73	KEN35662.....	77	OLVRH114.....	40	RH109.....	40
KEN32120.....	73	KEN35663.....	77	OLVRH116.....	40	RH111.....	40
KEN32121.....	73	KEN35695.....	77	OLVRH1160-390.....	42	RH112.....	40
KEN32123.....	74	KEN35697.....	77	OLVRH707-50.....	42	RH114X.....	40
KEN32125.....	74	KEN35795.....	77	OLVRH708-50.....	42	RH160XV.....	42
KEN32126.....	74	KEN35924.....	74	OR220TG.....	119	RH116X.....	40
KEN32127.....	74	KEN35926.....	74	OR224TG.....	119	RH120.....	40
KEN32128.....	74	KEN35936.....	74	OR24JM.....	119	RH120X.....	40
KEN33195.....	73	KEN36001.....	76	OR25T.....	119	RH122.....	40
KEN33196.....	73	KEN36002.....	76	OR325T.....	119	RH122X.....	40
KEN33199.....	73	KEN36007.....	76	OR329T.....	119	RH129P.....	42
KEN33219.....	73	KEN36015.....	77	OR333T.....	119	RH140.....	40
KEN33220.....	73	KEN39805.....	73	OR339T.....	119	RH150.....	41
KEN33223.....	74	LINT003.....	66	OR345T.....	119	RH151.....	41
KEN33224.....	74	LINT005.....	66	OR349T.....	119	RH152.....	41
KEN33238.....	73	LINT009.....	66	OR3ST.....	119	RH154.....	41
KEN33239.....	73	LINT011.....	66	OR451T.....	119	RH156.....	41
KEN33341.....	74	LINT016.....	66	OR457T.....	119	RH18-3/8.....	40
KEN33342.....	74	LINT018.....	66	PB-ATC.....	31	RH300.....	41
KEN34121.....	73	LINT022.....	66	PB-B.....	31	RH302.....	41
KEN34122.....	73	LINT026-120.....	66	PE100360C.....	124	RH304.....	41
KEN34549.....	79	LINT026-240.....	66	PE100360S.....	124	RH306.....	41
KEN34644.....	72	LINT029.....	66	PE100720.....	124	RH308.....	41
KEN34645.....	72	LINT148.....	66	PE200576FE.....	124	RH310.....	41
KEN34645C.....	72	LRRP.....	22	PE200624.....	124	RH312.....	41
KEN34647.....	72	MH26470.....	38	PE2006245.....	124	RH314.....	41
KEN34648.....	74	MONM100.....	64	PE200624ST.....	124	RH601.....	41
KEN34652.....	74	MONM1721/24B.....	64	PE200624STR.....	124	RH603.....	41
KEN34747.....	72	MONM1721/24W.....	64	PE300360.....	124	RH605.....	41
KEN34748.....	72	MONM2427/32.....	64	PE300360.....	124	RH611.....	41
KEN34749.....	72	MONM2732/32W.....	64	PE300360ST.....	124	RH613.....	41
KEN34847.....	72	MONM2732/32WOC.....	64	PECL12.....	124	RH619.....	41
KEN34848.....	72	MONM3842/32W.....	64	PECL6.....	124	RH626.....	41

## Product Index

RH635.....	42	S146/R-4.....	99	SAL260685-220V.....	67	TECH6-116T.....	106
RH708.....	42	S146/R-5.....	99	SAL260685EL.....	67	TECH6-117.....	106
RM-1.....	126	S146/W-1.....	99	SAL260685P-110V.....	67	TECH6-118.....	106
RM-2.....	126	S146/W-2.....	99	SAL260685S.....	67	TECH6-119.....	106
RM-3.....	126	S146/W-3.....	99	SAL260686.....	67	TECH6-120.....	106
RM-4.....	126	S146/W-4.....	99	SAL260687-110V.....	68	TECH6-122.....	106
RM-5.....	126	S146/W-5.....	99	SAL260687-220V.....	68	TECH6-123.....	106
RP-11-8-11400096.....	93	S146/W-6.....	99	SAL260687S.....	68	TECH6-125.....	106
RP11-8314813.....	91	S146A.....	99	SAL260687S110V.....	68	TECH6-127.....	106
RP6 0343B.....	90	S146B.....	99	SAL260688.....	68	TECH6-129.....	106
RSR-26.....	11	S2000.....	43	SBCT16.....	69	TECH6-138.....	106
S1009.....	43	S2001.....	43	SBCT22.....	69	TECH6-139.....	106
S1010C.....	46	S2002.....	43	SCBR16.....	69	TECH6-152.....	106
S1010K.....	46	S2003.....	43	SCBR22.....	69	TECH6-201.....	105
S1011.....	43	S2004.....	43	SIP.....	37	TECH6-203.....	105
S1011-1.....	43	S2005.....	43	SK12R.....	15	TECH6-203B.....	105
S1016.....	66	S2006.....	43	SK16R.....	15	TECH6-204.....	105
S1016-220.....	66	S2007.....	43	SK20R.....	15	TECH6-206B.....	105
S1032AC.....	46	S2008.....	43	SK24R.....	15	TECH6-207.....	105
S1035.....	46	S2009.....	43	SLP6550.....	46	TECH6-207B.....	105
S1036.....	46	S2010.....	43	SM101608.....	92	TECH6-207C.....	105
S1037.....	46	S2011.....	43	SM102529.....	90	TECH6-208.....	105
S1039.....	46	S2020.....	43	SM1120.....	85	TECH6-209D-1.....	105
S104/38.....	47	S2020-104.....	45	SM56T.....	87	TECH6-209D-1C.....	105
S1040.....	47	S2021.....	43	SM825.....	86	TECH6-209E.....	105
S1041.....	47	S2022.....	43	SM900.....	86	TECH6-210.....	105
S1043.....	47	S2023.....	43	SM915ATI.....	86	TECH6-210H.....	105
S1044.....	47	S20270.....	40	SM951.....	85	TECH6-211.....	105
S1045.....	46	S20270.....	43	SM951HPA.....	85	TECH6-213.....	105
S1046D.....	42	S2032.....	43	SP204/16.....	45	TECH6-213B.....	105
S1046D.....	47	S2040.....	45	SP208/16.....	45	TECH6-215A.....	105
S1046D.....	47	S2042.....	45	SP208/36.....	45	TECH6-216.....	105
S1047.....	47	S2043.....	45	SS10.....	37	TECH6-218.....	105
S1047XL.....	47	S2045.....	45	TBP25.....	30	TECH6-220B.....	105
S1048.....	45	S2046.....	45	TBP8.....	30	TECH6-225.....	105
S1048.....	47	S2047.....	45	TEC-AXFG-16-009.....	101	TECH6-228.....	105
S1049.....	45	S2204.....	43	TEC-AXFG-16-010.....	101	TECH6-228T.....	105
S1049.....	47	S870.....	44	TEC-AXFG-16-011.....	101	TECH6-230.....	105
S1055N.....	101	S872.....	44	TECH1-1400-1.....	106	TECH6-230BK.....	105
S1056.....	101	S872S.....	44	TECH2-128.....	106	TECH6-231C.....	105
S145/R-1.....	99	S873.....	44	TECH3-150.....	106	TECH6-235.....	105
S145/R-2.....	99	S874.....	44	TECH3-162.....	106	TECH6-236.....	105
S145/R-3.....	99	S875.....	44	TECH3-162A.....	106	TECH6-240.....	105
S145/R-4.....	99	S879.....	44	TECH3-163.....	106	TECH6-266.....	105
S145/R-5.....	99	S897.....	44	TECH3-164.....	106	TECH6-266BK.....	105
S145/W-1.....	99	S898.....	44	TECH3-172.....	106	TECH6-312.....	106
S145/W-2.....	99	S918.....	101	TECH56-1002.....	107	TECH6-313.....	106
S145/W-3.....	99	S920.....	101	TECH6-102.....	106	TECH966.....	38
S145/W-4.....	99	S923.....	101	TECH6-103.....	106	TECH974.....	38
S145/W-5.....	99	S924.....	101	TECH6-104.....	106	TECHRSB3.....	42
S145/W-6.....	99	S925.....	101	TECH6-108.....	106	TECHRSB3E.....	42
S145A(110V).....	99	S946.....	44	TECH6-109.....	106	TECHS890.....	44
S145A-IND.....	99	S947.....	44	TECH6-110.....	106	TECHS891.....	44
S145B(220V).....	99	SAL260270P-110V.....	67	TECH6-111.....	106	TJ20B.....	78
S146/R-1.....	99	SAL2602TOP-220V.....	67	TECH6-112.....	106	TJ20BA.....	78
S146/R-2.....	99	SAL260683.....	68	TECH6-114.....	106	TJ20BAS.....	78
S146/R-3.....	99	SAL260685-110V.....	67	TECH6-115.....	106	TJ325LP.....	79

## Product Index

TL100	125	TMRLP621	96	TPTS55	125	VH60GRY	112
TL150	125	TMRLP622	96	TR413CH/50	108	VH643	114
TL200	125	TMRLP623	96	TRI20008	108	VH645	114
TL250	125	TMRMI17-100	98	TRI4/50	108	VH646	114
TLP60	125	TMRMI17-25	98	TRI412	109	VH651	60
TM300	125	TMRMI197-100	98	TRI412L	109	VH651	60
TM400	125	TMRMI197-50	98	TRI413/500	108	VH651RH	60
TM500	125	TMRMI20	98	TRI415/50	108	VH651RH	60
TMRAG107518	94	TMRMI200	98	TRI418/500	108	VH652RH	60
TMRAG107985	94	TMRMI203-50	98	TRI425	108	VH652VH652RH	60
TMRBL11	97	TMRMI204-50	98	TRMTC181354	94	VH652VH652RH	60
TMRBL14	97	TMRMI215-100	98	TRMTC2505	94	VH653	60
TMRBL14W	97	TMRMI225-100	98	TRMTI149	97	VH653	60
TMRBL17W	97	TMRMI245-100	98	TRMTI151	97	VH65558	116
TMRBL24	97	TMRMI27-25	98	TRMTI152	97	VH656/58	112
TMRBL4	97	TMRMI297-50	98	TRMTI154	97	VH65658	116
TMRBL6	97	TMRMI305-50	98	TRMTI155	97	VH660	60
TMRBL8	97	TMRMI306-50	98	TRMTI55	94	VH663	60
TMRBL8W	97	TMRMI309-25	98	TRRP	22	VH666	121
TMRBS10	95	TMRMI309-25	98	TRT105	38	VH666CLR	121
TMRBS17-2	95	TMRMI315-100	98	TSN100	70	VH667	60
TMRBS22-2	95	TMRMI325-100	98	VCC84	63	VH670	120
TMRCB433796	95	TMRMI397-100	98	VH3215	120	VH671	120
TMRCB69	95	TMRMI430-25	98	VH3216	120	VH672	120
TMRCB6914-10	95	TMRTI146	97	VH34	113	VH673	120
TMRCB90488	95	TMRTI147	97	VH35	113	VH674	120
TMRCCL24	97	TMRTI148	97	VH36	113	VH675	120
TMRCST1	95	TMRTI30	94	VH37	113	VH683	120
TMRCT768	94	TMRTI8435	97	VH43OHT-F	113	VH686	62
TMRCW10-50	45	TMRWL98063	94	VH52	111	VH687	62
TMRCW1-50	45	TOR	126	VH553	111	VH688	62
TMRCW15-50	45	TOR10H	19	VH553C	111	VH689	62
TMRCW5-50	45	TOR10R	19	VH553E	111	VH694	62
TMRHA106871	94	TOR11R	19	VH554D	111	VH695	62
TMRHA67715	94	TOR1H	19	VH555D	111	VH82	112
TMRIMI235-100	98	TOR1R	19	VH555E	111	VH822	113
TMRLB106259	94	TOR2H	19	VH580	115	VH823	113
TMRLB106572	94	TOR2R	19	VH582	115	VH936A	115
TMRLB66006	94	TOR3H	19	VH584	115	VH936B	115
TMRLP600	96	TOR3R	19	VH591	21	VHB9A	115
TMRLP601	96	TOR4H	19	VH592	21	VHC15	63
TMRLP602	96	TOR4R	19	VH595	115	VHC27	63
TMRLP603	96	TOR5H	19	VH597	115	VHC28	63
TMRLP605	96	TOR5R	19	VH598	121	VHC37	63
TMRLP606	96	TOR6H	19	VH599	121	VHC38	63
TMRLP607	96	TOR6R	19	VH599RK	121	VHC803	63
TMRLP608	96	TOR7H	19	VH601	114	VHC809	63
TMRLP609	96	TOR7R	19	VH602HP	109	VHC810	63
TMRLP610	96	TOR8H	19	VH602HP	114	VHC83	63
TMRLP612	96	TOR8R	19	VH603	114	VHC85	63
TMRLP613	96	TOR9H	19	VH604	120	VHCEZ12	63
TMRLP615	96	TOR9R	19	VH605	120	VHCEZ14	63
TMRLP616	96	TP6000	125	VH606	120	VHI407	109
TMRLP617	96	TP7000	125	VH607	120	VHI430A	109
TMRLP618	96	TPTS275	125	VH608	120	VHI430HT/1	113
TMRLP619	96	TPTS32	125	VH609	120	VHI521MS	109
TMRLP620	96	TPTS5	125	VH60GRN	112	VHI53/1	112

## Product Index

VHI53/1S	112	VHI691	62	VHIBLE98TP	113	VHIN325-27	111
VHI542	110	VHI692	62	VHIBLH11	114	VHIN327-27	111
VHI543/BG	110	VHI696	62	VHIBLH21	114	VHIV3121	112
VHI5433/BG	110	VHI698	62	VHIBLH22	114	VHIV3131	112
VHI543D/BG	110	VHI722MS	110	VHICAPS	112	VHIV3141	112
VHI543E/BG	110	VHI723MS/BG	110	VHIE321	112	VHIV416-20/BG	109
VHI544/BG	110	VHI724-23/BG	110	VHIE32217	112	VHIV5101	115
VHI544E/BG	110	VHI724MS/BG	110	VHIE323	112	VHIVC2	112
VHI545/BG	110	VHI72590	110	VHIE324-27	112	VHIVC8-G	112
VHI545E/BG	110	VHI725MS/BG	110	VHIE325-27	112	VHJ440	113
VHI546/BG	110	VHI72690	110	VHIE326-27	112	VHJ4450	115
VHI546D/BG	110	VHI726MS/BG	110	VHIE327-27	112	VHJ450	113
VHI546E/BG	110	VHI72790	110	VHIEV37NI-N	109	VHJ4600	115
VHI594	115	VHI727MS/BG	110	VHIEV42NI	109	VHJ4750	115
VHI596	115	VHI72890	110	VHIFV250	114	VHJ4900	115
VHI600HP	109	VHI728MS/BG	110	VHIFVE125	114	VHJ59	116
VHI638	109	VHI729MS/BG	110	VHIFVE140	114	VHJ6100	62
VHI651-45	109	VHI734/BG	110	VHIFVE160	114	VHJ6102	62
VHI657	109	VHI736/BG	110	VHIFVE160B	114	VHJ6105	62
VHI661	60	VHI755/BG	111	VHIFVE180	114	VHJ67	116
VHI662	60	VHI756/BG	111	VHIFVE180B	114	VHJ690	115
VHI664	60	VHI758/BG	111	VHIFVE210	114	VHJ7678	116
VHI664	60	VHI801HP	109	VHIFVE270B	114	VHJ7734	116
VHI665	60	VHIBLE108TP	113	VHIFVE280	114	VHJ7900	116
VHI665	60	VHIBLE133TP	113	VHIH668	61	VHJ829	113
VHI665M	61	VHIBLE153TP	113	VHIH698	61	VHJAD4	115
VHI668	60	VHIBLE163TP	113	VHIJ651	115	VHJSP2	115
VHI668	60	VHIBLE29B45	113	VHIJ652	115	VHP698L	61
VHI669	60	VHIBLE34TP	113	VHIN321	111	VHSC	126
VHI669	60	VHIBLE4B90	113	VHIN3221	111		
VHI690	62	VHIBLE78TP	113	VHIN324-27	111		





# Looking for a rewarding career... become a TECH Distributor and join a worldwide network that has been providing innovative industry leading products for over 80 years!

TECH supplies the Truck, Automotive, Agriculture, Off The Road (OTR), Retread and even Recreational vehicle repair shops with a complete line of tire & wheel service products. With the breadth and number of vehicles in service today, there is an ongoing need for products to keep them rolling day after day, year after year.

In becoming a TECH Distributor, you will receive in-depth training at TECH's International Training Center on all facets of being a TECH Distributor. Your training includes:

- How to organize and manage business operations
- Product Knowledge
- Inventory management
- Route Building
- Marketing & Promotions
- Merchandising Your Truck
- Understanding Competitive Products
- Professional Sales 101
- Field Training & Support
- And Much More



By becoming a TECH Distributor, you not only enjoy a rewarding career, but you build a family-owned business that can be passed to the next generation, as TECH has numerous multi-generational Distributors. To learn more about becoming a TECH Distributor, please contact [distributorinfo@trc4r.com](mailto:distributorinfo@trc4r.com).

